



# POCKET PRO

ELECTRICAL SYSTEMS

Kraloy<sup>®</sup> Conduit Fittings

Kraloy<sup>®</sup>JBOX<sup>™</sup> Junction Boxes

Kraloy<sup>®</sup>JBOX<sup>™</sup> Hinged Covers

Kwikon<sup>®</sup> ENT & Fittings

INEXO<sup>™</sup> Electrical Boxes for ICF Construction

Kwikflex<sup>®</sup> NMLT Flexible Conduit & Fittings

Sceptalight<sup>™</sup> Nonmetallic Light Fixtures

SceptaCon<sup>™</sup> Trenchless Raceway

Type Designation	UL Underwriters Laboratories Inc. (UL 50 and UL 50E)
1	Indoor use primarily to provide protection against contact with the enclosed equipment and against a limited amount of falling dirt.
2	Indoor use to provide a degree of protection against limited amounts of falling water and dirt.
3	Outdoor use to provide a degree of protection against windblown rain; undamaged by the formation of ice on the enclosure.
4	Either indoor or outdoor use to provide a degree of protection against falling rain, splashing water, and hose-directed water; undamaged by the formation of ice on the enclosure.
4X	Either indoor or outdoor use to provide a degree of protection against falling rain, splashing water, and hose-directed water; undamaged by the formation of ice on the enclosure; resists corrosion.
6P	Indoor or outdoor use primarily to provide a degree of protection against hose-directed water, the entry of water during prolonged submersion at a limited depth, and be undamaged by the formation of ice on the enclosure.
12	Indoor use to provide a degree of protection against dust, dirt, fiber flyings, dripping water, and external condensation of noncorrosive liquids.
13	Indoor use to provide a degree of protection and spraying of water, oil, and noncorrosive liquids.

This material is reproduced with permission from Underwriters Laboratories Inc. Standard for Safety for Cabinets and Boxes, UL 50, and Industrial Control Equipment, UL 50E, by Underwriters Laboratories Inc.

Underwriters Laboratories Inc. (UL) shall not be responsible to anyone for the use of or reliance upon a UL Standard by anyone. UL shall not incur any obligation or liability for damages, including consequential damages, arising out of or in connection with the use, interpretation of, or reliance upon a UL Standard.

Introduction . . . . .	1
Applications . . . . .	2
Advantages . . . . .	3
Solvent Cementing . . . . .	6
Expansion and Contraction . . . . .	9
Applicable Standards . . . . .	16
PVC Conduit Fittings . . . . .	17
Fittings . . . . .	17
Gang Plates . . . . .	41
Weatherproof Covers . . . . .	42
Gang Boxes . . . . .	44
Floor Boxes . . . . .	46
Boxes . . . . .	49
Junction Box Adapters . . . . .	50
Standard Junction Boxes . . . . .	41
Cements and Primers . . . . .	52
Kraloy® JBox™ . . . . .	55
Sceptalight™ LED: Nonmetallic Light Fixtures . . . . .	61
Options . . . . .	65
EPR Conduit Repair Kit . . . . .	66
Kwikon® ENT . . . . .	67
ENT Tubing . . . . .	70
Couplings/Connectors . . . . .	71
Slab Boxes . . . . .	74
ENT Wall Boxes . . . . .	76
Short Form Sample Specifications . . . . .	78
INEXO® Electrical Boxes for ICF Construction . . . . .	81
Kwikflex® . . . . .	83
Nonmetallic Liquidtight Flexible Conduit . . . . .	84
Nonmetallic Liquidtight Fittings . . . . .	84
Interlocking Spacers . . . . .	87
Sceptacon™ Trenchless Raceway . . . . .	91



## Applications

Typical industrial, commercial and residential applications for Kraloy electrical systems include:

- Residential single & multi family dwellings
- Food processing plants
- Fish processing plants
- Agricultural
- Bridges and tunnels
- Airports
- Car washes
- Marinas
- Sewage treatment plants
- Water treatment plants
- Pulp and paper
- Street and highway lighting
- Utilities
- Communications
- Cable



## Advantages

### Labor Savings

Compared to yesterday's metal products, PVC reduces labor on typical installations by as much as two-thirds, because it is easy to work with. PVC does not require the labor intensive tools usually associated with steel products, such as vises, threading equipment and reamers.

### Easy Joining

Solvent cementing is all that is required, eliminating the need for power-threading machines, pipe vises and cutting equipment. A hacksaw or carpenter's saw is the only equipment required.

### Strength

Kraloy PVC fittings offer both high impact and high tensile strength.

### Corrosion Resistant

PVC is resistant to external corrosion and pitting and will not rust. This ensures a lower maintenance cost and a longer performance life.

### Nonconductive

PVC eliminates the most dangerous second point of contact in phase to ground faults. The use of a separate grounding conductor gives a complete and positive ground for the entire system.

### Chemical Resistant

One of the greatest benefits of PVC is its excellent chemical resistance. Kraloy PVC fittings are resistant to a wide range of chemicals such as acids, alkalis or salt solutions. For more information on chemical resistance, contact Kraloy customer service.

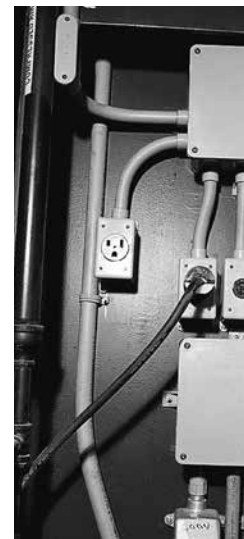

### Aging Characteristics

After years of exposure to direct sunlight, heat, and extreme weather, Kraloy PVC fittings retain their original properties. They are also resistant to fungi, bacterial action, rodents and termites, providing for a long and trouble free life.

### Fire Resistance

As a building material PVC offers outstanding fire performance characteristics. PVC will not burn unless an external flame source is applied, and will not sustain ignition once the flame source is removed. PVC has a flash ignition temperature of 850°F.



Depend on Kraloy® for quality products and superior service

#### KRALOY® JBOX w/ Hinged Cover

- Available in 8" to 16" sizes
- Hand-close fastener tabs
- 100% nonmetallic

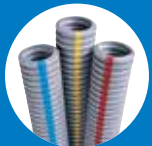
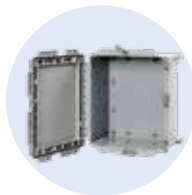

#### Kwikon® ENT and Fittings

- Available in 1/2" to 2" sizes
- Easy installation for time and labour savings
- Complete concrete-tight system



### Kraloy PVC Conduit Fittings

This section provides comprehensive information and guidelines for the design and installation of PVC Schedule 40 and 80 conduit and fittings. Always consult the authority having jurisdiction for specific installation procedures.

## Solvent Cementing

After cutting PVC rigid conduit, sharp edges or burrs from inside the conduit should be removed with a knife. Thoroughly clean the end of the pipe and inside the fitting with a pipe cleaner. In extreme weather conditions, a primer should be used to prepare the joint for solvent cementing. Apply a generous amount of solvent cement to both surfaces, slide together and give a quarter turn to ensure solvent is spread evenly on the material. Hold together for a few seconds until the joint is made.



Usually the solvent-cemented joint will be strong enough to install immediately, but in low temperatures and high humidity, extra time may be required before moving the pipe to install it permanently. Solvent cemented joints appear to “set up” instantly, but will take 24 hours to cure properly. After this time, the solvent-cemented joint has completely cured and is waterproof. Kraloy cement is available in half-pint, pint, quarts and one-gallon containers.

## Handling

Solvent cements should be used as received in original containers. Adding thinners to change viscosity is not recommended. If cement is jelly-like and not free-flowing, it should not be used. Containers should be kept tightly covered when not in use.

## Storage Conditions

Solvent cements should be stored at temperatures between 40°F and 110°F away from heat or open flame. Cements should be used before the expiry date stamped on the container. If new cement is subjected to freezing temperatures, it may become extremely thick. This cement can be placed in a warm area where it will soon return to its original, usable condition. However, if the product is gelled or hardened due to actual solvent loss (when a container is left open too long during use or not sealed properly after use), the cement will not return to its original condition. Cement in this condition has lost its formulation and should be discarded in an environmentally friendly manner.

## Safety Precautions

Solvent cements are extremely flammable and should not be used or stored near heat or open flame. In confined or partially enclosed areas, a ventilating device should be used to remove vapors and minimize inhalation. Containers should be kept tightly closed when not in use, and covered as much as possible when in use. Avoid frequent contact with the skin. In case of eye contact, flush repeatedly with water. Keep out of the reach of children.

## Cold Weather

Although normal installation temperatures are between 40°F to 110°F, high strength joints have been made at temperatures as low as -15°F. However, the installer must ensure he has adequately softened the joining surfaces with a primer. In addition, cement must be kept warm to prevent excessive thickening and gelation in cold weather.

Initial Set Schedule for PVC Solvent Cements\*

Temp. Range	Pipe Size 1/2" to 1-1/4"	Pipe Size 1-1/2" to 2"	Pipe Size 2-1/2" to 6"
60° - 100°F	2 min.	3 min.	30 min.
40° - 60°F	5 min.	8 min.	2 hrs.
0° - 40°F	10 min.	15 min.	12 hrs.

NOTE: Initial set schedule is the necessary time to allow before the joint can be carefully handled.

\*These figures are estimates based on our laboratory tests. Due to the many variables in the field, these figures should be used as a general guide only.

After initial set, the joints will withstand the stresses of a normal installation. (A misaligned installation will cause excessive stresses in the joint). For long runs of pipe, care should be taken not to disturb joints for 1/2 to 1-1/2 hours before handling or burying.

Average Number of Joints per Pint or Quart of Cement

Nominal Pipe Size (Inches)	# of Joints per Pint	# of Joints per Quart	Nominal Pipe Size (Inches)	# of Joints per Pint	# of Joints per Quart
1/2	350	700	2-1/2	40	80
3/4	200	400	3	35	70
1	150	300	3-1/2	30	60
1-1/4	110	220	4	24	48
1-1/2	80	160	5	10	20
2	45	90	6	8	16

## Expansion and Contraction

All conduit pipe and fittings expand and contract with changes in temperature. All materials' expansion and contraction rates are represented by coefficients of thermal expansion.

A general rule of thumb is that for every 100°F temperature change in a 100 ft. run of PVC conduit, the conduit will undergo 3.6" of expansion or contraction.

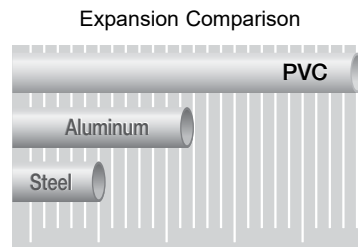

## Use of Expansion Joints

In installations where the expected temperature variation exceeds 25°F expansion joints must be used. An expansion joint consists of two tubes, one telescoping inside another. When installing expansion joints alignment of the piston and barrel is important. Straps should be placed approximately one foot on either side of the joint to ensure that any movement is directed squarely into the joint.

Rule of Thumb  
for PVC Expansion

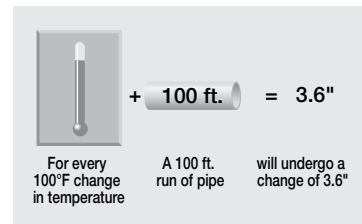



When expansion joints are required the following steps should be followed:

### 1. DETERMINE NUMBER OF JOINTS REQUIRED:

Use the following formula to calculate the total expected expansion in the run.

$$\text{Total expansion} = \frac{\text{Total temp. change } ^\circ\text{F}}{10} \times \frac{\text{Length of run ft.}}{100} \times .36$$

The expansion joints should then be installed at even intervals throughout the run.

$$\text{Number of joints} = \frac{\text{Total expansion}}{4}$$

Example:

Assume a 200 ft. run of conduit is to be installed in an unheated building where the temperature will vary from 10°F in the winter to 110°F in the summer. The installation will be carried out when the temperature is 60°F.

Using step 1 we determine the number of joints required.

$$\text{Total Expansion} = \frac{100^\circ\text{F}}{10} \times \frac{200 \text{ ft.}}{100} \times .36 = 7.2"$$

$$\text{Number of joints} = \frac{7.2}{4} = 1.8$$

Note: Always round off to the next highest number. Therefore in this example we see that two expansion joints are necessary.

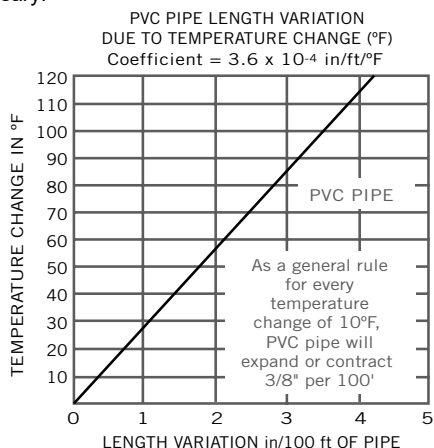

### 2. DETERMINE PISTON OPENING:

The expansion joint must be installed to allow both expansion and contraction of the conduit run. Because installation temperatures may vary, the piston setting must be determined. The correct piston opening is determined using the following formula:

$$\text{Piston setting} = \text{Compressed length} + \left( \frac{\text{max. temp.} - \text{installation temp.}}{\text{max. temp.} - \text{min. temp.}} \right) \times E$$

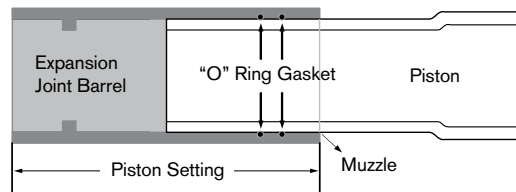

Size (in)	Compressed Length (in)	Travel (in)
1/2	8.00	4
3/4	8.00	4
1	8.50	4
1-1/4	9.00	4
1-1/2	9.00	4
2	9.25	4
2-1/2	14.25	8
3	14.25	8
3-1/2	14.90	8
4	14.90	8
5	26.00	8
6	26.00	8

## Location of Expansion Joints

Proper functioning of an expansion joint depends on three procedures:

1. The correct placement of the expansion joint.
2. The proper installation of rigid PVC conduit and the expansion joint.
3. The proper placement and fastening of support straps.

## ONE EXPANSION JOINT

### FIGURE 1

If only one expansion joint is needed between two boxes, the barrel of the joint should be rigidly fastened close to the first box. Rigid PVC conduit should then be loosely supported with straps, allowing the conduit to move freely as it expands and contracts.

## TWO EXPANSION JOINTS

### FIGURE 2

If two expansion joints are needed, the joints should be firmly fastened back to back at the center of the run. Rigid PVC conduit should be loosely supported with straps, allowing the conduit to move freely as it expands and contracts.

## TWO EXPANSION JOINTS (ALTERNATIVE)

### FIGURE 3

Alternatively, the center of the run and the two expansion joints (located at the boxes) should be rigidly fastened. All other support straps should be loosely fastened.

## THREE OR MORE EXPANSION JOINTS

### FIGURE 4

If more than two joints are needed in a very long run, they should be put in a series, one after the other. Each barrel must be rigidly fastened while conduit is loosely supported with straps allowing the conduit to move freely as it expands and contracts. When installed in a series, each section acts independently of the other. Spacing of conduit supports must be in accordance with NEC article 347-8.

FIGURE 1

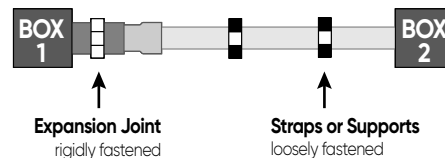

FIGURE 2

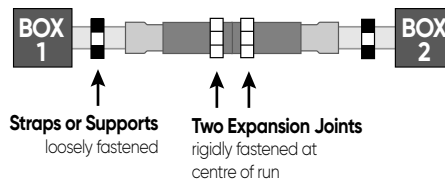

FIGURE 3

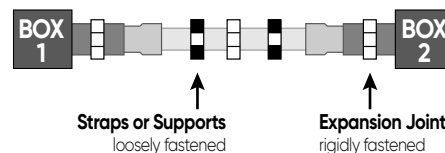
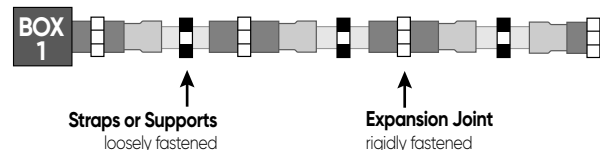

FIGURE 4



### Legend

- : Guide or Hanger
- : Anchor

## Installation of Expansion Joints

Installation recommendations:

- Expansion joints should be mounted so the piston can travel in a straight line in the barrel. If the alignment is not straight, the piston will bind, preventing the joint from working correctly.
- The expansion joint barrel should be clamped tight, but the conduit mounted loose enough in its hangers to allow for movement as it expands and contracts.
- Kraloy nonmetallic straps are correctly sized and designed for proper support, and must be used to secure the conduit.
- When expansion joints are used in a vertical position, the piston should be mounted in a downward position so dirt cannot deposit between the barrel and piston at the muzzle of the expansion joints.

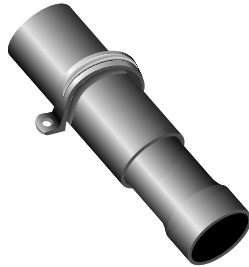

## Common Mistakes

Three common mistakes are:

1. Forgetting to use expansion joints.
2. Not using enough expansion joints.
3. Overtightening of support straps.

It is more cost effective to use more expansion joints than needed, rather than too few. It is difficult to correct the problem after conductors are installed and in service. Failure to accommodate expansion/contraction may result in pipe fracture.

## Installation of the One Piece Expansion Joint (OPEJ)

1. Solvent cement the PVC conduit into the conduit hub of the OPEJ and firmly secure the PVC conduit on the solvent cement side of the OPEJ using Kraloy pipe straps.
2. Set the expansion fitting by marking a line 11/2" from the end of the conduit to be inserted and insert the conduit into the OPEJ to this mark.
3. Secure and support the conduit raceway using Kraloy pipe straps.

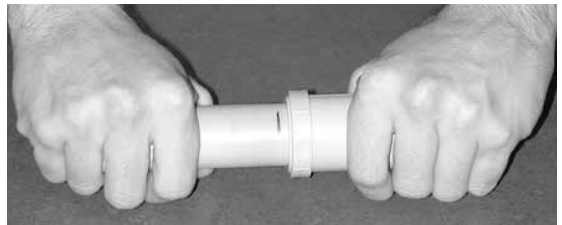
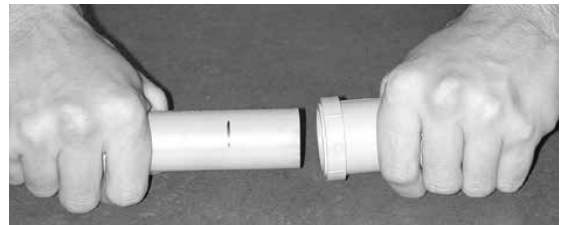

## Applicable Standards

### Underwriters Laboratories

UL50	Enclosures for Electrical Equipment
UL514B	Fittings for Cable & Conduit
UL514C	Nonmetallic Outlet Boxes, Flush-Device Boxes & Covers
UL651	Schedule 40 & 80 Rigid PVC Conduit

### Canadian Standards Association

CSA C22.2 No. 18	Outlet Boxes, Fittings & Associated Hardware
CSA C22.2 No. 40	Cutout, Junction & Pull Boxes
CSA C22.2 No. 42	General Use Receptacles, Attachment Plugs & Similar Wiring Devices
CSA C22.2 No. 85	Rigid PVC Boxes & Fittings
CSA C22.2 No. 94	Special Purpose Enclosures
CSA C22.2 No. 211.0	General Requirements & Methods of Testing Nonmetallic Conduit
CSA C22.2 No. 211.1	Rigid Types EB1 & DB2/ES2 PVC Conduit
CSA C22.2 No. 211.2	Rigid PVC (Unplasticized) Conduit
CSA C22.2 No. 227.1	Electrical Nonmetallic Tubing
CSA C22.2 No. 227.2	Flexible Liquid-Tight Nonmetallic Conduit

### National Electrical Manufacturers Association

NEMA TC3	PVC Fittings for use with Rigid PVC Conduit & Tubing
NEMA TC2	Electrical Plastic Tubing (EPT) & Conduit (EPC-40 & EPC-80)
NEMA TC9	Fittings for ABS & PVC Plastic Utilities Duct for Underground Installation
NEMA 250	Enclosures for electrical Equipment (1000 Volts Maximum)

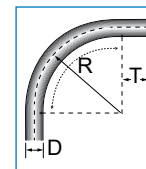

### Schedule 40 Standard Radius 90° Elbows

Size (in.)	Part Number	Product Code	A (in.)	B (in.)	C (in.)
1/2	40STD0590	078540	0.840	1.500	4.000
3/4	40STD0790	078541	1.050	1.500	4.500
1	40STD1090	078542	1.315	1.875	5.750
1-1/4	40STD1290	078543	1.660	2.000	7.250
1-1/2	40STD1590	078544	1.900	2.000	8.250
2	40STD2090	078545	2.375	2.000	9.500
2-1/2	40STD2590	078546	2.875	3.000	10.500
3	40STD3090	078547	3.500	3.125	13.000
3-1/2	40STD3590	078548	4.000	3.250	15.000
4	40STD4090	078549	4.500	3.375	16.000
5	40STD5090	078550	5.563	3.625	24.000
6	40STD6090	078551	6.625	3.750	30.000

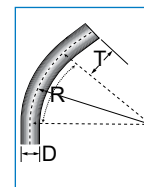

### Schedule 40 Standard Radius 45° Elbows

Size (in.)	Part Number	Product Code	A (in.)	B (in.)	C (in.)
1/2	40STD0545	078552	0.840	1.500	4.000
3/4	40STD0745	078553	1.050	1.500	4.500
1	40STD1045	078554	1.315	1.875	5.750
1-1/4	40STD1245	078555	1.660	2.000	7.250
1-1/2	40STD1545	078556	1.900	2.000	8.250
2	40STD2045	078557	2.375	2.000	9.500
2-1/2	40STD2545	078558	2.875	3.000	10.500
3	40STD3045	078559	3.500	3.125	13.000
3-1/2	40STD3545	078560	4.000	3.250	15.000
4	40STD4045	078561	4.500	3.375	16.000
5	40STD5045	078562	5.563	3.625	24.000
6	40STD6045	078563	6.625	3.750	30.000

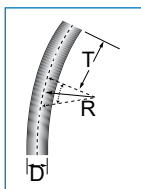

### Schedule 40 Standard Radius 30° Elbows

Size (in.)	Part Number	Product Code	A (in.)	B (in.)	C (in.)
1/2	40STD0530	078564	0.840	1.500	4.000
3/4	40STD0730	078565	1.050	1.500	4.500
1	40STD1030	068622	1.315	1.875	5.750
1-1/4	40STD1230	078567	1.660	2.000	7.250
1-1/2	40STD1530	078568	1.900	2.000	8.250
2	40STD2030	078569	2.375	2.000	9.500
2-1/2	40STD2530	078570	2.750	3.000	10.500
3	40STD3030	078571	3.500	3.125	13.000
3-1/2	40STD3530	078572	4.000	3.250	15.000
4	40STD4030	078573	4.500	3.375	16.000
5	40STD5030	078574	5.563	3.625	24.000
6	40STD6030	078575	6.625	3.750	30.000

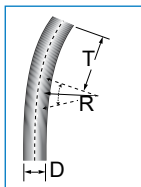

### Schedule 40 Standard Radius 22-1/2° Elbows

Size (in.)	Part Number	Product Code	A (in.)	B (in.)	C (in.)
1-1/2	40STD1522	078580	1.900	2.000	8.25
2	40STD2022	078581	2.375	2.000	9.50
2-1/2	40STD2522	078582	2.875	3.000	10.50
3	40STD3022	078583	3.500	3.125	13.00
3-1/2	40STD3522	078584	4.000	3.250	15.00
4	40STD4022	078585	4.500	3.375	16.00
5	40STD5022	078586	5.563	3.625	24.00
6	40STD6022	078587	6.625	3.750	30.00

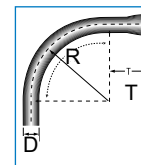

### Schedule 40 Standard Radius 90° Bell End Elbows

Size (in.)	Part Number	Product Code	A (in.)	B (in.)	C (in.)
1/2	B40STD0590	078588	0.840	1.500	4.000
3/4	B40STD0790	078589	1.050	1.500	4.500
1	B40STD1090	078590	1.315	1.875	5.750
1-1/4	B40STD1290	078591	1.660	2.000	7.250
1-1/2	B40STD1590	078592	1.900	2.000	8.250
2	B40STD2090	078593	2.375	2.000	9.500
2-1/2	B40STD2590	078594	2.875	3.000	10.500
3	B40STD3090	078595	3.500	3.125	13.000
3-1/2	B40STD3590	078596	4.000	3.250	15.000
4	B40STD4090	078597	4.500	3.375	16.000
5	B40STD5090	068430	5.563	3.625	24.000
6	B40STD6090	078599	6.625	3.750	30.000

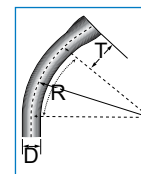

### Schedule 40 Standard Radius 45° Bell End Elbows

Size (in.)	Part Number	Product Code	A (in.)	B (in.)	C (in.)
1/2	B40STD0545	078600	0.840	1.500	4.000
3/4	B40STD0745	078601	1.050	1.500	4.500
1	B40STD1045	078602	1.315	1.875	5.750
1-1/4	B40STD1245	078603	1.660	2.000	7.250
1-1/2	B40STD1545	078604	1.900	2.000	8.250
2	B40STD2045	078605	2.375	2.000	9.500
2-1/2	B40STD2545	078606	2.875	3.000	10.500
3	B40STD3045	078607	3.500	3.125	13.000
3-1/2	B40STD3545	078608	4.000	3.250	15.000
4	B40STD4045	078609	4.500	3.375	16.000
5	B40STD5045	078610	5.563	3.625	24.000
6	B40STD6045	068572	6.625	3.750	30.000

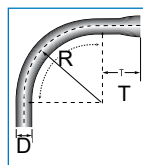

**Schedule 80  
Standard Radius 90° Elbows**

Size (in.)	Part Number	Product Code	A (in.)	B (in.)	C (in.)
1/2	80STD0590	078620	0.840	1.500	4.000
3/4	80STD0790	078621	1.050	1.500	4.500
1	80STD1090	078622	1.315	1.875	5.750
1-1/4	80STD1290	078623	1.660	2.000	7.250
1-1/2	80STD1590	078624	1.900	2.000	8.250
2	80STD2090	078625	2.375	2.000	9.500
2-1/2	80STD2590	078626	2.875	3.000	10.500
3	80STD3090	078627	3.500	3.125	13.000
4	80STD4090	078628	4.500	3.375	16.000
5	80STD5090	078629	5.563	3.625	24.000
6	80STD6090	078630	6.625	3.750	30.000

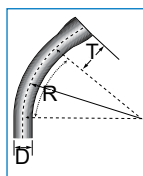

**Schedule 80  
Standard Radius 45° Elbows**

Size (in.)	Part Number	Product Code	A (in.)	B (in.)	C (in.)
1/2	80STD0545	078631	0.840	1.500	4.000
3/4	80STD0745	078632	1.050	1.500	4.500
1	80STD1045	078633	1.315	1.875	5.750
1-1/4	80STD1245	078634	1.660	2.000	7.250
1-1/2	80STD1545	078635	1.900	2.000	8.250
2	80STD2045	078636	2.375	2.000	9.500
2-1/2	80STD2545	078637	2.875	3.000	10.500
3	80STD3045	078638	3.500	3.125	13.000
4	80STD4045	078639	4.500	3.375	16.000
5	80STD5045	078640	5.563	3.625	24.000
6	80STD6045	078641	6.625	3.750	30.000

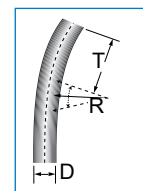

**Schedule 80  
Standard Radius 30° Elbows**

Size (in.)	Part Number	Product Code	A (in.)	B (in.)	C (in.)
1/2	80STD0530	078642	0.840	1.500	4.000
3/4	80STD0730	078643	1.050	1.500	4.500
1	80STD1030	078644	1.315	1.875	5.750
1-1/4	80STD1230	078645	1.660	2.000	7.250
1-1/2	80STD1530	078646	1.900	2.000	8.250
2	80STD2030	078647	2.375	2.000	9.500
2-1/2	80STD2530	078648	2.750	3.000	10.500
3	80STD3030	078649	3.500	3.125	13.000
4	80STD4030	078650	4.500	3.375	16.000
5	80STD5030	078651	5.563	3.625	24.000
6	80STD6030	068560	6.625	3.750	30.000



## Repair Kit for Conduit

Total repair systems for broken and damaged PVC Conduit



Available in  
1-1/4" to 6" sizes



KRALOY  
CONDUIT  
FITTINGS

KRALOY  
CONDUIT  
FITTINGS

Conduit Elbows  
Schedule 40 Special Radius (Plain End)

Size inches	Degree Bend	18" Radius Product Code	24" Radius Product Code	30" Radius Product Code	36" Radius Product Code	48" Radius Product Code	60" Radius Product Code
1	90	068702	068722	068742	068762	068782	#
	45	068802	068822	068842	068862	068882	#
	30	068902	068922	068942	068962	068982	#
	22-1/2	078853	078035	#	278288	#	#
1-1/4	90	068703	068723	068743	068763	068783	#
	45	068803	068823	068843	068863	068883	#
	30	068903	068923	068943	068963	068983	#
	22-1/2	068513	078667	#	#	#	#
1-1/2	90	068704	068724	068744	068764	068784	#
	45	068804	068824	068844	068864	068884	#
	30	068904	068924	068944	068964	068984	#
	22-1/2	068523	078668	#	#	#	#
2	90	068705	068725	068745	068765	068785	068113
	45	068805	068825	068845	068865	068885	#
	30	068905	068925	068945	068965	068985	#
	22-1/2	068514	068547	#	068515	178065	#
2-1/2	90	068706	068726	068746	068766	068786	178168
	45	068806	068826	068846	068866	068886	#
	30	068906	068926	068946	068966	068986	#
	22-1/2	068524	078275	#	278229	#	#
3	90	068707	068727	068747	068767	068787	068114
	45	068807	068827	068847	068867	068887	#
	30	068907	068927	068947	068967	068987	#
	22-1/2	068516	068525	#	068517	068526	#
3-1/2	90		068728	068748	068768	068788	178169
	45	Use Std. Sch. 40 Radius (15")	068828	068848	068868	068888	#
	30		068928	068948	068968	068988	#
	22-1/2		068130	#	#	#	#
4	90		068729	068749	068769	068789	068112
	45	Use Std. Sch. 40 Radius (16")	068829	068849	068869	068889	078011
	30		068929	068949	068969	068989	#
	22-1/2		068518	068519	068520	068521	068111
5	90			068751	068771	068791	068115
	45	Use Std. Sch. 40 Radius (24")		068851	068871	068891	078615
	30			068951	068971	068991	068132
	22-1/2			068529	068522	078485	#
6	90				068772	068792	078937
	45	Use Std. Sch. 40 Radius (30")			068872	068892	078220
	30				068972	068992	178255
	22-1/2				068528	068527	078221
8	90	-	-	-	-	068052	#
	45	-	-	-	-	068082	#
	22-1/2	-	-	-	-	068081	#
	11-1/4	-	-	-	-	068080	#

Note: 1) # indicates available on request. Material is non-cancelable and non-returnable.

Note: 2) Larger Radius Elbows are available on request and are non-cancelable and non-returnable.

Conduit Elbows

Schedule 40 Special Radius (Belled One End)

Size inches	Degree Bend	18" Radius Product Code	24" Radius Product Code	36" Radius Product Code	48" Radius Product Code
2	90	068014	068030	068054	068078
	45	068015	068033	068055	068079
2-1/2	90	068016	068034	068056	068086
	45	068017	068035	078508	068090
3	90	068018	068036	068058	068091
	45	068019	068037	078513	068092
3-1/2	90	Use Std. Sch. 40	068038	068070	068093
	45	Radius (15")	068039	068071	068094
4	90	Use Std. Sch. 40	068050	068072	068095
	45	Radius (16")	078945	068073	068096
5	90	Use Std. Sch. 40 Radius (24")		068074	068097
	45			068075	068098
6	90	Use Std. Sch. 40 Radius (30")		068076	068099
	45			068077	068106

- Note: 1) # indicates available on request. Material is non-cancelable and non-returnable.  
 2) 30° and 22-1/2° Elbows are available on request.  
 3) Larger Radius Elbows are available on request and are non-cancelable and non-returnable.

Conduit Elbows

Schedule 80 Special Radius (Plain End)

Size inches	Size inches	18" Radius Product Code	24" Radius Product Code	30" Radius Product Code	36" Radius Product Code	48" Radius Product Code
1	90	068710	078374	#	068049	068541
	45	#	#	#	178194	#
1-1/4	90	068711	068735	#	#	068542
	45	#	078114	#	#	#
1-1/2	90	068712	078854	#	068545	068543
	45	178104	078113	#	#	#
2	90	068713	068736	078910	068775	068544
	45	#	068530	#	068534	078198
2-1/2	90	068714	068737	078524	068776	068548
	45	#	068531	#	068535	#
3	90	068715	068738	078525	068777	068794
	45	#	068532	#	068536	#
4	90	068716	068739	068549	068778	068795
	45	#	068533	#	068537	078911
5	90	Use Standard Schedule 80 Radius		078373	068779	068796
	45	(24")		#	068538	068546
6	90	Use Standard Schedule 80 Radius (30")			068540	068797
	45				068539	078966



### Couplings

Size (in.)	Part Number	Product Code	N Min (in.)	OD (in.)	OL (in.)
1/2	CP05	078001	0.06	1.06	1.41
3/4	CP07	078002	0.07	1.27	1.54
1	CP10	078003	0.10	1.55	1.86
1-1/4	CP12	078004	0.11	1.95	2.02
1-1/2	CP15	078005	0.08	2.18	2.26
2	CP20	078006	0.10	2.68	2.39
2-1/2	CP25	078007	0.17	3.24	3.12
3	CP30	078008	0.17	3.94	3.34
3-1/2	CP35	078009	0.20	4.48	3.62
4	CP40	078010	0.23	5.00	3.77
5	CP50	078012	0.27	6.12	4.17
6	CP60	078014	0.26	7.29	4.88
8	CP80	178192	-	-	-

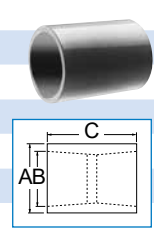

### 5° couplings B x B

Size (in.)	Part Number	Product Code	L (in.)
2	5EC20	078049	4.0
3	5EC30	078051	6.0
4	5EC40	178375	7.0
5	5EC50	178376	7.5
6	5EC60	077106	11.0
5	5EC60	277093	7.5
6	5EC65	077106	11.0

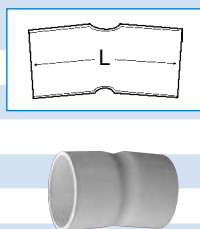

### 5° couplings B x S

Size (in.)	Part Number	Product Code	L (in.)
2	5EC20BS	078025	4.0
3	5EC30BS	078026	6.0
4	5EC40BS	078028	7.0
6	5EC60BS	078030	11.0

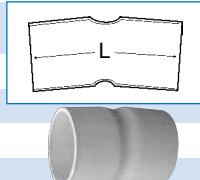

### Long Line Couplings

Size (in.)	Part Number	Product Code	L (in.)
2	LLC20	078063	3.68
2-1/2	LLC25	078065	4.28
3	LLC30	078066	4.80
4	LLC40	078067	6.20
5	LLC50	078068	8.22
6	LLC60	078069	8.22
6	LLC65	077198	8.22

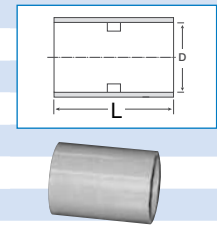

### Repair Coupling Sleeves

Size (in.)	Part Number	Product Code	L (in.)	D Min (in.)	D Max (in.)
1-1/2	REC15	077292	2.30	1.91	1.92
2	REC20	278617	6.50	2.37	2.40
2-1/2	REC25	078041	3.45	2.88	2.90
3	REC30	278618	6.50	3.51	3.52
4	REC40	278619	8.00	4.51	4.52
5	REC50	278620	8.00	5.58	5.60
6	REC60	278621	8.00	6.65	6.67

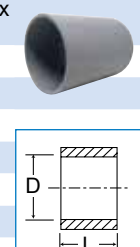

### Offset Terminal Adapters

Size S x H (in.)	Part Number	Product Code	OL (in.)
1-1/4	MO12	078351	4.24
2	MO20	078352	4.36



### Meter Hubs

Size (in.)	Part Number	Product Code
1-1/4	MHU25	077961
1-1/2	MHU30	077963
2	MHU35	077965
2-1/2	MHU40	077967
3	MHU45	077968

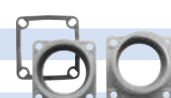

## Terminal Adapters

Size (in.)	Part Number	Product Code	OL (in.)	TL Min (in.)
1/2	TA05	078084	1.31	0.55
3/4	TA07	078085	1.44	0.57
1	TA10	078086	1.78	0.80
1-1/4	TA12	078087	1.86	0.80
1-1/2	TA15	078088	1.98	0.80
2	TA20	078089	2.07	0.81
2-1/2	TA25	078090	2.48	0.82
3	TA30	078091	2.58	0.77
3-1/2	TA35	078092	2.82	0.92
4	TA40	078093	2.87	0.87
5	TA50	078094	3.71	1.39
6	TA60	078095	3.54	1.08
8	TA80	178190	-	-

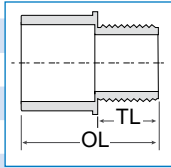

## Female Adapters

Size (in.)	Part Number	Product Code	OL (in.)	TL Min (in.)
1/2	FA05	078070	1.40	0.70
3/4	FA07	078071	1.55	0.77
1	FA10	078072	2.00	1.00
1-1/4	FA12	078073	2.07	1.00
1-1/2	FA15	078074	2.19	1.00
2	FA20	078075	2.26	1.00
2-1/2	FA25	078076	2.29	1.00
3	FA30	078077	2.95	1.15
3-1/2	FA35	078078	4.10	1.80
4	FA40	078079	3.12	1.15
5	FA50	078080	3.75	1.52
6	FA60	078081	4.06	1.50
8	FA80	178189	-	-

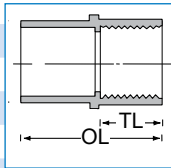

## Reducer Bushings

Size (in.)	Part Number	Product Code
3/4 x 1/2	MR0705	078353
1 x 1/2	MR1005	078354
1 x 3/4	MR1007	078355
1-1/4 x 3/4	MR1207	078356
1-1/4 x 1	MR1210	078357
1-1/2 x 1	MR1510	078359
1-1/2 x 1-1/4	MR1512	078360
2 x 1	MR2010	078361
2 x 1-1/4	MR2012	078363
2 x 1-1/2	MR2015	078362
2-1/2 x 2	MR2520	078364
3 x 2	MR3020	078365
3 x 2-1/2	MR3025	078366
4 x 2	ME4020	078369
4 x 3	MR4030	078367
4 x 3-1/2	MR4035	078368



## Fabricated Swedge Reducer Couplings Soc x Soc

Size (in.)	Part Number	Product Code
2 x 1-1/4	SW2012	078398
2 x 1-1/2	SW2015	078399
2-1/2 x 2	SW2520	078400
3 x 2	SW3020	078401
3 x 2-1/2	SW3025	078402
3-1/2 x 3	SW3530	078404
4 x 2	SW5535	077322
4 x 3	SW4030	078407
4 x 3-1/2	SW4035	078408
5 x 4	SW5040	078409
6 x 5	SW6050	078410



## End Bells

Size (in.)	Part Number	Product Code	OD (in.)	OL (in.)
1/2	MEB05	078288	1.25	1.00
3/4	MEB07	078289	1.50	1.00
1	MEB10	078290	1.75	1.12
1-1/4	MEB12	078291	2.09	1.20
1-1/2	MEB15	078292	2.95	1.50
2	MEB20	078293	3.05	1.44
2-1/2	MEB25	078294	3.59	1.79
3	MEB30	078295	3.87	1.91
3-1/2	MEB35	078296	4.44	2.09
4	MEB40	078297	4.87	2.18
5	MEB50	078298	6.19	2.38
6	MEB60	078299	7.19	2.57
8	MEB80	278123	-	-

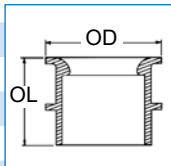

## End Caps

Size (in.)	Part Number	Product Code	A (in.)	B (in.)
1/2	EC05	078314	1.41	1.00
3/4	EC07	078315	1.63	1.13
1	EC10	078316	1.86	1.19
1-1/4	EC12	078317	2.01	1.28
1-1/2	EC15	078318	2.12	1.50
2	EC20	078319	2.45	1.81
2-1/2	EC25	078320	2.92	2.13
3	EC30	078321	3.05	2.38
3-1/2	EC35	277085	2.15	2.63
4	EC40	078323	3.26	3.05
5	EC50	077431	4.38	3.00
6	EC60	078325	5.18	4.13
8	EC80	178191	-	-

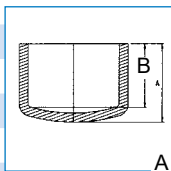

## Tapered Conduit Plugs

Size (in.)	Part Number	Product Code
2 - 2-1/2	UTP20	078424
3 - 3-1/2	UTP30	078425
4	UTP40	078427
5	UTP50	078428
6	UTP60	078429
8	UTP80	077648

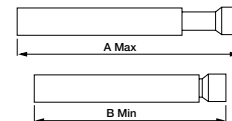

## Expansion Joints

Size (in.)	Part Number	Product Code	A Max (in.)	B Min (in.)
1/2	EJ05	178681	12.00	8.00
3/4	EJ07	078329	12.00	8.00
1	EJ10	078330	12.50	8.50
1-1/4	EJ12	078331	13.00	9.00
1-1/2	EJ15	078332	13.00	9.00
2	EJ20	078333	13.25	9.25
2-1/2	EJ25	078334	22.25	14.25
3	EJ30	078336	22.25	14.25
3-1/2	EJ35	078337	22.90	14.90
4	EJ40	078338	22.90	14.90
5	EJ50	078339	34.00	26.00
6	EJ60	078340	34.00	26.00

### One Piece Expansion Joints

Size (in.)	Part Number	Product Code
1/2	OPEJ05	078240
3/4	OPEJ07	078209
1	OPEJ10	078208
1-1/4	OPEJ12	078204
1-1/2	OPEJ15	078045
2	OPEJ20	078388



### Expansion and Deflection Fittings Assemblies\*

Size (in.)	Part Number	Product Code
2	SE-J-35	077889
3	SE-J-45	077890
4	SE-J-55	077891

complete assembly, \* Not Certified



### Slip Meter Risers (NEC Article 300)

Size (in.)	Part Number	Product Code
1-1/4	SMR12TA	068107
1-1/2	SMR15TA	068108
2	SMR20TA	068063
2-1/2	SMR25TA	068064
4	SMR30TA	068373
4	SMR40TA	068065



### Expansion Joint c/w Terminal Adapter

Size (in.)	Part Number	Product Code
2" x 4" of travel	EJ35TA	077680
2-1/2" x 12" of travel	EJ40TA	077398
3" x 8" of travel	EJ45TA	077681
4" x 8" of travel	EJ55TA	077682

### Pipe Straps, PVC 2 Hole

Size (in.)	Part Number	Product Code
1/2	PS05	078375
3/4	PS07	078376
1	PS10	078377
1-1/4	PS12	078378
1-1/2	PS15	078379
2	PS20	078380
2-1/2	PS25	178108
3	PS30	178109
4	PS40	178110



### Threaded Reducer Bushings

Size (in.)	Part Number	Product Code
3/4 x 1/2	1825	077314
1 x 1/2	1826	077315
1 x 3/4	1827	077316

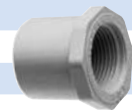

Pipe Straps, PVC Coated Steel 2 Hole

Size (in.)	Part Number	Product Code
2	PSC20	078190
2-1/2	PSC25	078191
3	PSC30	078192
3-1/2	PSC35	078193
4	PSC40	078194
5	PSC50	078195
6	PSC60	078196



Conduit Clamps & Spacers

Size (in.)	Part Number	Product Code	X (in.)	Y (in.)	Z (in.)
1/2	CCS10	278106	1.19	2.41	1.82
3/4	CCS15	278095	1.20	2.66	2.11
1	CCS20	278096	1.22	2.96	2.44
1-1/4	CCS25	278097	1.18	3.30	2.86
1-1/2	CCS30	278098	1.19	3.60	3.17
2	CCS35	278099	1.20	4.14	3.79
Base	CCS-B	278107	-	-	-

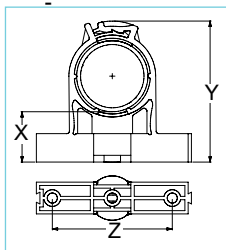

\* CCS-B are sold individually, two pieces are required to create one base unit.



Pull Elbow

Size (in.)	Part Number	Product Code
1/2 & 3/4	PULEL0705	078386

Access Fitting



TYPE LL    TYPE T    TYPE TB    TYPE LB    TYPE E    TYPE C    TYPE LR

Access Fitting Dimensions (except Type "LB")

Size (in)	A (in)	B (in)	C (in)	D (in)	E (in)	F (in)
1/2	5.6	0.6	1.3	1.1	0.8	4.3
3/4	5.6	0.8	1.5	1.3	1.1	5.4
1	6.5	0.9	1.7	1.6	1.3	6.3
1-1/4	7.9	1.1	2.3	2.0	1.7	7.6
1-1/2	8.5	1.1	2.7	2.3	1.9	8.3
2	10.9	1.2	3.2	2.8	2.4	10.5
2-1/2	14.6	1.8	4.5	4.0	2.9	13.6
3	14.6	1.9	4.5	4.0	3.5	13.6
3-1/2	17.0	2.1	5.5	5.0	4.0	16.0
4	17.0	2.1	5.5	5.0	4.5	16.0

Size (in)	G (in)	H (in)	I (in)	J (in)	K (in)	L (in)
1/2	4.1	1.3	2.5	2.3	1.0	0.8
3/4	4.1	1.3	2.5	2.8	1.0	0.8
1	4.8	1.5	2.1	3.3	1.1	1.1
1-1/4	5.8	1.8	3.6	4.0	1.6	1.0
1-1/2	6.5	1.8	3.9	4.3	1.7	1.1
2	8.2	2.3	4.5	5.4	2.0	1.2
2-1/2	9.8	3.8	6.2	7.3	2.6	-
3	10.9	2.7	6.2	7.3	2.6	-
3-1/2	11.5	4.5	7.5	8.5	3.0	-
4	11.5	4.5	7.5	8.5	3.0	-

All access fittings are UL listed for wet locations. Supplied with threaded brass inserts, brass screws, PVC gasket & cover.

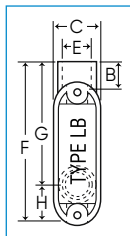

### Type 'LB' Access Fittings

Size (in.)	Part Number	Product Code	F (in.)	G (in.)	E (in.)	H (in.)	C (in.)
1/2	LB05	078140	4.285	3.290	1.500	1.175	1.312
3/4	LB07	078141	4.970	3.980	1.625	1.375	1.500
1	LB10	078142	5.900	4.656	2.010	1.665	1.750
1-1/4	LB12	078143	7.650	6.060	2.510	1.910	2.450
1-1/2	LB15	078144	7.812	6.180	2.520	2.187	2.468
2	LB20	078145	9.970	8.055	3.455	2.500	3.062
2-1/2	LB25	078146	13.750	11.843	4.625	3.375	4.625
3	LB30	078147	14.250	11.843	4.625	3.405	4.625
3-1/2	LB35	078148	15.500	12.750	5.450	4.210	5.445
4	LB40	078149	15.500	12.750	5.450	4.210	5.445

### Type 'LL' Access Fittings

Size (in.)	Part Number	Product Code
1/2	LL05	078152
3/4	LL07	078153
1	LL10	078154
1-1/4	LL12	078155
1-1/2	LL15	078156
2	LL20	078157
2-1/2	LL25	078158
3	LL30	078159
3-1/2	LL35	078160
4	LL40	078161

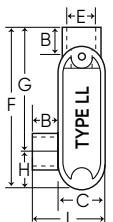

### Type 'T' Access Fittings

Size (in.)	Part Number	Product Code
1/2	T05	078176
3/4	T07	078177
1	T10	078178
1-1/4	T12	078179
1-1/2	T15	078180
2	T20	078181
2-1/2	T25	078182
3	T30	078183
3-1/2	T35	078184
4	T40	078185

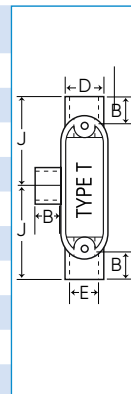

### Type 'TB' Access Fittings

Size (in.)	Part Number	Product Code
1/2	STB10S	077451
3/4	STB20S	077452
1	STB30S	077453
1-1/4	STB40S	077454
1-1/2	STB50S	077455
2	STB60S	077456

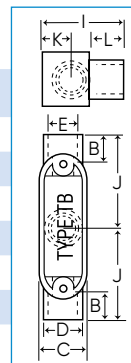

### Type 'E' Access Fittings

Size (in.)	Part Number	Product Code
1/2	E05	078128
3/4	E07	078129
1	E10	078130
1-1/4	E12	078131
1-1/2	E15	078132
2	E20	078133
2-1/2	E25	078134

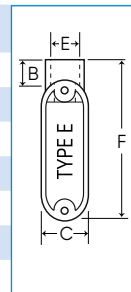

All access fittings are UL listed for wet locations.  
Supplied with threaded brass inserts, brass screws, PVC gasket & cover.

## Type 'C' Access Fittings

Size (in)	Part Number	Product Code
1/2	C05	078116
3/4	C07	078117
1	C10	078118
1-1/4	C12	078119
1-1/2	C15	078120
2	C20	078121
2-1/2	C25	078122
3	C30	078123
3-1/2	C35	078124
4	C40	078125

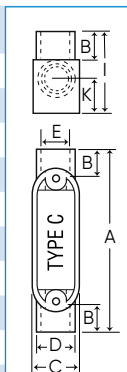

## Type 'LR' Access Fittings

Size (in)	Part Number	Product Code
1/2	LR05	078164
3/4	LR07	078165
1	LR10	078166
1- 1/4	LR12	078167
1-1/2	LR15	078168
2	LR20	078169
2-1/2	LR25	078170
3	LR30	078171
3-1/2	LR35	078172
4	LR40	078173

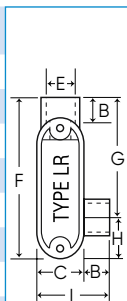

All access fittings are UL listed for wet locations.  
Supplied with threaded brass inserts, brass screws, PVC gasket & cover.

## Service Entrance Fittings

Size (in.)	Part Number	Product Code
1/2	MH05	078302
3/4	MH07	078303
1	MH10	078304
1-1/4	MH12	078305
1-1/2	MH15	078306
2	MH20	078307
2-1/2	MH25	078308
3	MH30	078309
3-1/2	MH35	078310
4	MH40	078311



## One Kit, Four Heights, One Low Cost!

This simple yet innovative Round Floor Box Stand is equipped with several height brackets which accommodate the different rebar and post-tension cable heights and slab depths found from jobsite to job-site. When installed together, the Floor Box and Stand can be used in 5-1/2" to 10" slab depths.



Sold as a Kit, Kraloy offers the Round Floor Box and Stand conveniently packaged together as one complete product offering.

## FEATURE &amp; BENEFITS

- Four Adjustable Heights
- Withstands Tough Job Site Conditions
- Raises Entrance Hubs to Rebar
- Easy to Install
- Minimizes Footprint on Concrete Form
- Cost Effective

## Nonmetallic Strain Relief Connectors

Kraloy's Nonmetallic Strain Relief Connectors are supplied with all the components you need for a complete connection. The connector body, a selection of grommets and compression rings accepting a range of cord dimensions, a sealing 'O' ring and metallic locknut are all supplied in one package. Available in 1/2" and 3/4" threaded hub and 3/4" PVC socket solvent weld configurations to accommodate a variety of applications.



## Threaded Strain Relief Connector

Size (in.)	Part Number	Product Code
1/2	TSRCU05	278100
3/4	TSRCU07	278101

## Strain Relief Connector

Size (in.)	Part Number	Product Code
3/4	SRCU07	278102



c/w 4 Grommets - 3/4" solvent weld male end

## Grommet Dimensions

Grommet	from	to	Grommet	from	to
	$\varnothing = .240"$	$\varnothing = .315"$		$\varnothing = .420"$	$\varnothing = .515"$
	$\varnothing = .320"$	$\varnothing = .415"$		$\varnothing = .520"$	$\varnothing = .615"$

Note: All four grommets and corresponding compression rings are supplied with TSRCU05, TSRCU07 & SRCU07.

## F Series - Single Gang Plates



DRC15/10 TSC15/10 20RC15/10 20-3RC15/10 30-3RC15/10 FSKIT

Description	Part Number	Product Code
Duplex Receptacle	DRC15/10	078889
Toggle Switch	TSC15/10	078898
Single Receptacle	20RC15/10	078882
Single Receptacle	20-3RC15/10	078913
Single Receptacle	30RC15/10	078914
Blank c/w Gasket	FSKIT	078241

## F Series - Double Gang Plates



BRC20-2-U TSC20-2-U DRC20-2-U TSDC20-2-U GASKFU20-2

Description	Part Number	Product Code
Blank Cover c/w Gasket	BRC20-2-U	278085
Double Switch	TSC20-2-U	278088
Double Duplex Receptacle	DRC20-2-U	278086
Combo Switch Duplex Rec.	TSDC20-2-U	278089
Foam Gasket with Adhesive	GASKFU20-2	172650

## F Series - Triple Gang Plates















BRC20-3 DRC20-3 DSDR20-3 TSC20-3 TSDC20-3

Description	Part Number	Product Code
Triple Receptacle	DRC20-3	278070
Combo Switch Receptacle	DSDR20-3	278071
Triple Switch	TSC20-3	278072
Combo Switch Receptacle	TSDC20-3	278073
Blank Cover c/w Gasket	BRC20-3	077748
Gasket for 3 Gang 'F' Boxes	GASK20-3	077749

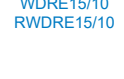
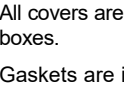

## Weatherproof Covers - Single Gang

VPT15/10	Description	(in)	Part Number	Product Code
	Plunger-style Switch Cover		VPT15/10	078899
	Toggle Switch Cover		VSC15/10	078900
	Grey Toggle Switch Cover		WTG15/10	078903
	Grey Duplex Receptacle		WDR15/10	078901
	White Duplex Receptacle		RWDR15/10	078843
	Grey Ground Fault Receptacle		WGF15/10	078902
	White Ground Fault Receptacle		RWGF15/10	078844
	Single Receptacle Device 15 AMP	1.375	WTL15	078904
	Single Receptacle Device 20 AMP	1.625	WTL20	078905
	30 AMP Twist-Lock	1.722	WTL30	078906
	50 AMP Twist-Lock	2.187	WTL50	078909
	Grey Double Door Duplex Receptacle		WDRE15/10	078326
	White Double Door Duplex Receptacle		RWDRE15/10	078383
	Gasket for W Series Cover (except WDRE & RWDRE)		GASKW	077755
	Gasket for WDRE & RWDRE Covers		GASKDD	072225

All covers are universal and will fit on most PVC and metal boxes.

Gaskets are included with all weatherproof covers.

## Weatherproof Covers - Double Gang

Description	Part Number	Product Code
	VSC20-2-U	278090
	VSRC20-2-U	278092
	VSDRU20-2-U	278091
	VSGG20-2	078327
	VSDD20-2	078335
Gasket for Double Gang 'F' Boxes (except VSGG20-2 & VSDD20-2)	GASKF20-2-U	172650
Gasket for VSGG20-2 & VSDD20-2 Double Gangs	GASKV20-2	072227

All covers are universal and will fit on most PVC and metal boxes.

Gaskets are included with all weatherproof covers.

## F Series Single Gang Boxes

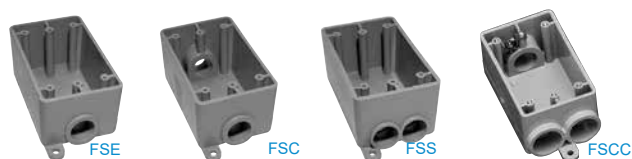

Size (in.)	Part Number	Cubic Inch Capacity	Product Code	L (in.)	W (in.)	D (in.)
1/2	FSE05	17.5	078229	4.58	2.82	2.0
3/4	FSE07	17.5	078230	4.58	2.82	2.0
1/2	FSC05	17.0	078226	4.58	2.82	2.0
3/4	FSC07	17.0	078227	4.58	2.82	2.0
1/2	FSS05	17.0	078232	4.58	2.82	2.0
3/4	FSS07	17.0	078233	4.58	2.82	2.0
1/2	FSCC05	16.3	078235	4.65	2.85	2.0
3/4	FSCC07	16.3	078236	4.65	2.85	2.0

## FD Series Single Gang Deep Boxes

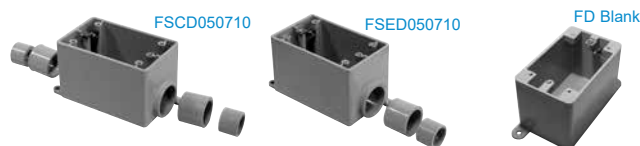

Size (in.)	Part Number	Cubic Inch Capacity	Product Code	L (in.)	W (in.)	D (in.)
1/2, 3/4, 1	FSCD050710	26.0	278051	4.58	2.82	2.76
1/2, 3/4, 1	FSED050710	26.8	278050	4.58	2.82	2.76
BLANK	FD	29.0	078215	4.54	2.79	2.91

## F Series Single Gang Deep Boxes



Size (in.)	Part Number	Cubic Inch Capacity	Product Code	L (in.)	W (in.)	D (in.)
1/2, 3/4, 1	FDS101520ST	26.0	077847	4.58	2.82	2.76
1/2, 3/4, 1	FDC101520ST	26.8	077849	4.58	2.82	2.76

Screws are not included.

## F Series Double Gang Boxes

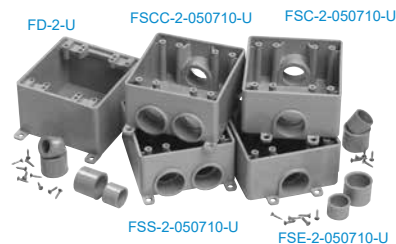

Size (in.)	Part Number	Cubic Inch Capacity	Product Code	L (in.)	W (in.)	D (in.)
1/2, 3/4, 1	FSE-2-050710-U	38.5	278082	4.62	4.62	2.5
1/2, 3/4, 1	FSS-2-050710-U	37.0	278087	4.62	4.62	2.5
1/2, 3/4, 1	FSC-2-050710-U	37.0	278083	4.62	4.62	2.5
1/2, 3/4, 1	FSCC-2-050710-U	35.0	278084	4.62	4.62	2.5
BLANK	FD-2-U	47.5	278038	4.75	4.75	3.0

## F Series Triple Gang Boxes

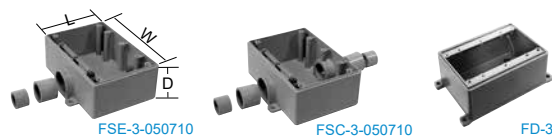

Size (in.)	Part Number	Cubic Inch Capacity	Product Code	L (in.)	W (in.)	D (in.)
1/2, 3/4, 1	FSE-3-050710	56.0	278067	4.50	6.06	2.5
1/2, 3/4, 1	FSC-3-050710	54.0	278068	4.50	6.06	2.5
BLANK*	FD-3	56.0	278069	4.1	6.73	3.1

\* Not UL Listed

### Round Floor Box Stand

This simple yet innovative Round Floor Box Stand is equipped with several height brackets which accommodate the different rebar and post-tension cable heights and slab depths. When installed together, the Floor Box and Stand can be used in 5-1/2" to 10" slab depths.



#### FEATURES:

- Four adjustable heights
- Raises entrance hubs to rebar height
- Minimizes footprint on concrete form
- Withstands tough job site conditions
- Easy to install
- Cost effective

The Round Floor Box easily snaps into the Stand on one of the four convenient height brackets at 2-1/2", 3", 3-1/2" and 4". By raising the Floor Box off the concrete form, the footprint is minimized which reduces the amount of time the contractor spends finishing the concrete surface. In addition, the various Stand heights allow the ENT to enter the box in a flat and straight path, resulting in less effort by the contractor when pulling in the electrical cable.

Part Number	Product Code
FBS-KIT	178269

### Nonmetallic Floor Box, Cover & Metal Cover Adapter

Installation is quick and simple with our nonmetallic floor box and covers, saving both time and money over similar metallic assemblies.

Kraloy's floor box and duplex receptacle covers are constructed from high impact, noncorroding and nonconducting PVC. The flush mount covers are available in custom colors and are shipped with a leveling ring. Metal cover adapter kits are also available, allowing you to adapt to metal floor plates. Our 6" deep floor box allows flexibility for various concrete floor pours, while our 4 3/4" width offers easy access and ample wire room. The box comes complete with 2 - 1" and 2 - 3/4" hub openings.

All boxes are shipped complete with reducer plugs (2 - 1 x 3/4, 3 - 3/4 x 1/2) for added versatility.

Description	Part Number	Product Code
-------------	-------------	--------------

<b>Floor Box</b>	FB	078876
(includes disposable protective cap & reducer plugs) suitable for slab-on-grade or below grade, and wood floor construction		



FB

<b>Floor Box Kit</b>	FBKIT	078908
c/w Universal leveling ring adapter, disposable protective cap and reducer plugs		



FBKIT

<b>Metal Cover Adapter Kit</b>	AFMC	078875
(includes leveling ring, metal cover adapter ring & two shim gaskets for height adjustment)		



AFMC

<b>Universal Leveling Ring Adapter</b>	LRA-U	078446
--	-------	--------

<b>Floor Box Duplex Receptacle Cover (Nonmetallic)</b>	LRA-U	
(includes flush mount cover, blank cover & gasket) accepts standard duplex receptacle (not included)		



LRA-U

	Brown FBDRCB	078877
	Gold FBDRCG	078878
	Grey FBDRCGr	078618
	Light Almond FBDRCA	078841



FBDRC

<b>Tri-Service Universal Divider Kit</b>	FBUDK	078993
(includes upper & lower dividers, riser tube & four grommets) Kit partitions the round PVC floor box to permit power, communication and/or data cabling in one location and within the same box		



FBUDK

<b>Y Connector</b>	FBYC	078928
use y connector to feed through (in/out) or to bring a parallel run of 3/4" conduit to the same hub		



FBYC

### Brass and Nickel Cover Plates

These cover plates help to protect enclosed power data and communications wiring from daily environmental floor conditions such as mopping (UL scrub water tested) and foot traffic (UL approved for cover loading).



The covers feature a light lacquer finish for extra strength and durability in high traffic areas and include a rubber gasket and aluminum backing plate to create a water-tight seal. The flush mount cover plates should be installed to the floor box using the LRA-U.

### Nickel Cover Plates

Description	Part Number	Product Code
Duplex Receptacle Cover with Dual Flip Lid	DFL-2-N	178279
Duplex Receptacle Cover with Individual Screw Plug Openings	SSC-N	178278
Combination 2" x 1/2" Single Screw Plug Opening	DSC-N	178280



DFL-2-N



SSC-N



DSC-N

### Brass Cover Plates

Description	Part Number	Product Code
Duplex Receptacle Cover with Dual Flip Lid	DFL-2	178096
Duplex Receptacle Cover with Individual Screw Plug Openings	SSC	178093
Combination 2" x 1/2" Single Screw Plug Opening	DSC	178091
Combination 2" x 1/2" Single Screw Plug and 1/2" Datacomm Opening	DSC-P/C	178092



DFL-2



SSC



DSC

### Octagonal Boxes\*

Octagonal Boxes are shipped complete with cover, gasket, 4 reducing bushings (3/4" x 1/2") and 3 knock-out plugs to be installed from inside box to seal off unused entry hubs.



### Octagonal Boxes

Size (in)	Hub Size (in)	Part Number	Product Code	L	D
4 x 1 1/2	1/2 + 3/4	OB401505/07	078414	4	1.68
4 X 2 1/8	1	OB402010	078415	4	2.25

### Octagonal Box Extension Rings\*

Size (in)	Hub Size (in)	Part Number
4 x 1 deep	XR20	077989
4 x 2 deep	XR35	077990



\* Octagonal Boxes are not designed for supporting luminaires.  
\* LFB150T complete with 1/2 threaded hole in center of cover.

### Threaded Round Box

Kraloy's Threaded Junction Boxes are corrosion resistant, non-conductive and incorporate high-temperature silicone gaskets and brass hardware to withstand extreme temperature variations. Manufactured from glass-reinforced thermoplastic polyester resin, these boxes can endure extreme temperatures (material temperature range -40°F to +302°F).

Size (in)	Hub Size (in)	Part Number	OD (in)
4 - 3/4" Threaded Hubs	LFB150C	077250	4.475
4 - 3/4" Threaded Hubs	LFB150T*	077251	4.475

\*LFB150T complete w/ 1/2" threaded hole in center of cover



LFB150C



LFB150T

### Junction Box Adapters

Junction Box Adapters, installed using a standard PVC coupling, offer a trouble-free and reliable PVC connection. In addition to providing a strong connection, the JBA also maximizes the interior box wiring space unlike the use of male adapters (TA) and facilitates wire pulling - the smooth internal edges limiting the potential for wire damage.

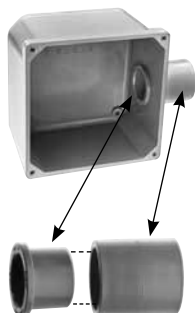

Junction Box Adapter    Standard PVC Coupling

Junction box and couplings sold separately

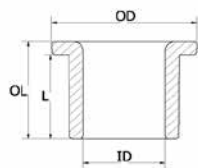

Size (in.)	Part Number	Product Code	ID (in.)	OD (in.)	L (in.)	OL (in.)
1/2	JBA05	078276	0.62	1.20	0.81	0.95
3/4	JBA07	078277	0.79	1.40	0.87	1.01
1	JBA10	078278	1.00	1.58	0.89	1.06
1-1/4	JBA12	078279	1.35	1.98	1.12	1.30
1-1/2	JBA15	078280	1.59	2.37	1.10	1.33
2	JBA20	078281	2.05	2.85	1.25	1.54
2-1/2	JBA25	078282	2.45	3.34	1.68	1.99
3	JBA30	078283	3.05	3.10	1.77	2.11
3-1/2	JBA35	078284	3.54	4.50	2.09	2.41
4	JBA40	078285	4.02	5.03	1.99	2.30

### Junction Boxes

Junction boxes are supplied with threaded brass inserts, brass screws, PVC gasketing and mounting feet. Larger sizes of fabricated junction boxes, are available upon request.

Kraloy PVC Junction Boxes are:  
NEMA 1, 2, 3, 4, 4X, 6P, 12, 13  
UL listed for wet locations

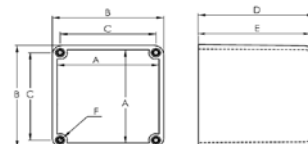

Size (in)	Part Number	Part Number	A	B	C	D	E	F
			(inches)					
4x4x2	JB442	078242	3.71	4.05	3.42	2.15	1.99	8-32
4x4x4	JB444	078243	3.65	4.00	3.43	4.17	4.02	8-32
4x4x6	JB446	078244	3.65	4.02	3.43	6.23	6.00	8-32
5x5x2	JB552	078245	4.66	5.00	4.50	2.00	1.85	8-32
6x6x4	JB664	078246	6.08	6.41	5.80	4.20	4.00	8-32
6x6x6	JB666	078247	6.02	6.38	5.80	6.00	6.21	8-32
8x8x4	JB884	078248	8.06	8.60	7.95	4.18	3.97	1/4-20
8x8x7	JB887	078249	8.10	8.60	7.95	7.24	7.00	1/4-20
12x12x4	JB12124	078250	11.93	12.48	11.84	4.26	4.00	1/4-20
12x12x6	JB12126	078251	11.97	12.36	11.80	6.25	5.99	1/4-20
12x12x8	JB12128	078252	11.90	12.50	11.84	8.24	7.96	1/4-20

External mounting feet are supplied with all sizes except JB442 and JB552.

## Clear Conduit Cement

Choosing the correct cement is a vital link in a thermoplastic piping system. Although cement is one of the most critical components of a piping system, it is most often overlooked. Cements are formulated to best meet specific needs—for example, general-purpose cement is thinner and less aggressive in bonding than heavy-duty industrial cement. Use Clear Conduit Solvent Cement Medium Bodied to create solid, waterproof joints when connecting electrical PVC conduit pipe. The cement is approved for use with rigid PVC conduit such as Kraloy's Rigid PVC conduit & fittings, Kwikon ENT and fittings, and Duct & fittings.

### Average Number of Joints per Pint or Quart of Cement

Nominal Pipe Size (inches)	Number of Joints per Pint	Number of Joints per Quart
1/2	350	700
3/4	200	400
1	150	300
1-1/4	110	220
1-1/2	80	160
2	45	90
2-1/2	40	80
3	35	70
3-1/2	30	60
4	24	48
5	10	20
6	8	16

## Cements and Primers

Size	Part Number	Product Code
Clear Regular Bodied Solvent Cement (Low VOC)		
1/2 Pint	CEMC05	078883
Pint	CEMC10	078884
Quart	CEMC20	078885
Gallon*	CEMC80	078887
Clear Medium Bodied Solvent Cement (Low VOC)		
Pint		078798
Quart		078799
Grey Medium Bodied Solvent Cement		
Pint	CEMG10	078083
Quart	CEMG20	078096
Cold Weather Solvent Cement		
Pint	CWC10	078503
Quart	CWC20	078886
ENT Solvent Cement (Low VOC)		
Quart	CCB100QT	078186
Clear Conduit Primer (Low VOC)		
Pint	PRMC10	078174
Quart	PRMC20	078175
Purple Primer (Low VOC)		
Quart	PRMP20	078054

All cements and primers come with applicator caps except were indicated with \*

## The RIGHT BOX for the RIGHT Environment



Kraloy JBox has expanded its offering to include 14" and 16" molded PVC junction boxes...the LARGEST available anywhere!

### FEATURES & BENEFITS

- NEMA 1,2,3R,4,4X,12,13
- 100% Nonmetallic
- Hand-close fastener tabs
- Back panels available for sizes 6" & up

Visit [www.kraloyfittings.com](http://www.kraloyfittings.com)



### Kraloy JBox

Introducing the Kraloy® JBox™, the Next Generation Junction Box. The original junction box is completely redesigned and features have been added to make this the easiest box to use. The patent pending integral gasket, non-metallic fasteners, molded mounting feet, embossed grid-lines and flat cover features have been engineered to provide a contractor-friendly junction box.

NEMA Rated: 1, 2, 3R, 4, 4X, 6\*, 6P\*, 12, 13

\*Applies only to 4" to 12" non-hinged covers



### FEATURES & BENEFITS

#### Hand-Close Fasteners

- Close by hand – tool assist to open
- 100% non-metallic – corrosion resistant material
- No loose hardware for easy installation

#### Smooth Flat Cover

- No ribs – offers a flat, smooth surface for mounting of devices or labels

#### Integrated Gasket

- Injection molded and extruded gaskets permanently fixed to the cover – no installation required
- Proprietary gasket material creates a 6P rated enclosure (4"–12")
- Neoprene gasket material creates a 4X rated enclosure (14"–16")

#### Molded Mounting Feet

- Molded – no loose parts to assemble
- Located on corners out of the way of conduit connections
- Flush with the back of the box for close surface mounting
- Integrated design of mounting feet offers improved strength

#### Built-in Gridlines

- Easy reference for drilling knockouts
- Makes conduit alignment a snap



Kraloy JBox

Size inches	Part Number	Product Code	L1	W1	L2	W2	H	M1	M2	G1	G2	J1	J2	D	K
4x4x2	JBX442	278300	4.97	3.93	3.48	3.48	2.90	4.48	3.44	2.41	1.09	1.72	1.09	0.51	0.24
4x4x4	JBX444	278301	4.90	3.86	3.48	3.48	4.89	4.41	3.37	2.22	2.97	1.59	2.97	0.59	0.24
5x5x2	JBX552	278302	5.97	4.93	4.55	4.55	2.90	5.48	4.44	3.41	1.09	2.69	1.09	0.51	0.24
6x3x4	JBX634	278303	3.90	5.86	2.48	5.48	4.89	3.41	5.37	1.22	2.72	3.42	2.72	0.59	0.28
6x6x4	JBX664	278304	7.58	7.58	5.86	7.20	4.90	6.90	6.90	4.47	2.47	4.47	2.47	0.59	0.28
6x6x6	JBX666	278305	7.51	7.51	5.79	7.13	6.90	6.83	6.83	4.22	4.47	4.22	4.47	0.72	0.28

Size inches	Part Number	Product Code	L1	W1	L2	W2	H	M1	M2	G1	G2	N1	N2	P1	P2	D	K
8x8x4	JBX884	278306	9.58	9.58	7.86	9.20	4.90	8.90	8.90	6.47	1.97	8.25	6.26	3.94	3.13	0.59	0.28
8x8x7	JBX887	278307	9.47	9.47	7.76	9.10	7.90	8.80	8.80	6.22	4.65	8.25	6.26	3.94	3.13	0.75	0.28
12x12x4	JBX12124	278308	13.58	12.24	11.74	11.74	4.90	12.90	11.56	9.28	2.03	10.26	10.25	3.94	3.13	0.56	0.28
12x12x6	JBX12126	278309	13.51	12.17	11.74	11.74	6.90	12.83	11.49	9.03	3.78	10.26	10.25	3.94	3.13	0.67	0.28
12x12x8	JBX12128	278310	13.44	12.10	11.74	11.74	8.90	12.76	11.42	8.81	5.64	10.26	10.25	3.94	3.13	0.76	0.28
14x14x8	JBX14148	278311	15.72	14.39	13.80	13.80	9.1	15.1	13.70	11.05	5.69	12.25	10.26	3.94	3.16	0.83	0.33
14x14x10	JBX141410	278312	15.66	14.32	13.80	13.80	11.1	15.0	13.64	11.05	7.55	12.25	10.26	3.94	3.16	0.83	0.33
16x16x10	JBX161610	278313	17.64	16.30	15.71	15.71	11.1	17.0	15.60	12.55	7.55	14.25	12.26	4.71	4.09	0.83	0.33

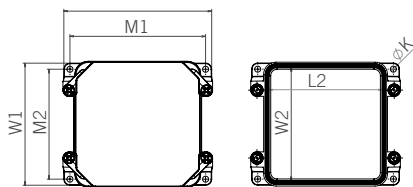

JBX442 - JBX666

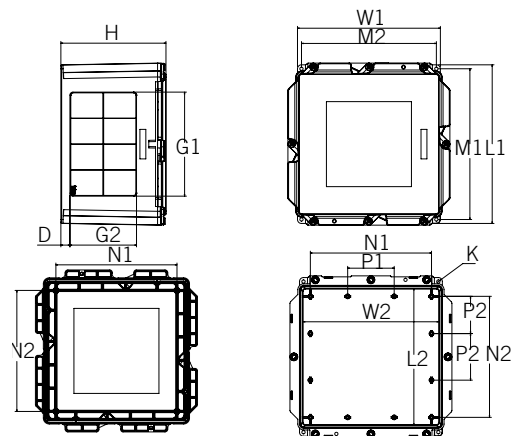

JBX884 - JBX887

JBX12124 - JBX161610

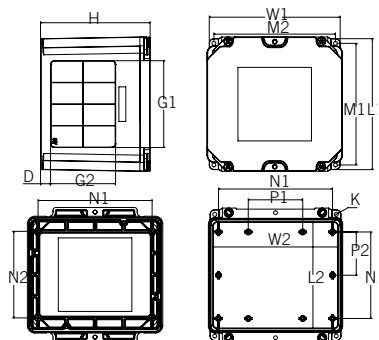
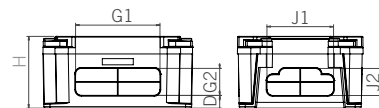



## Kraloy JBox with Hinged Cover

The Hinged Covers open up to 214° and are removable for complete and easy access to control devices and instrumentation. The Kraloy JBox Hinged Cover is NEMA 3R and 4X rated, ideally suited for indoor and outdoor industrial, MRO and OEM applications, and in wash-down environments. It is 100% nonmetallic and includes all the features that users have come to appreciate in the Kraloy JBox.

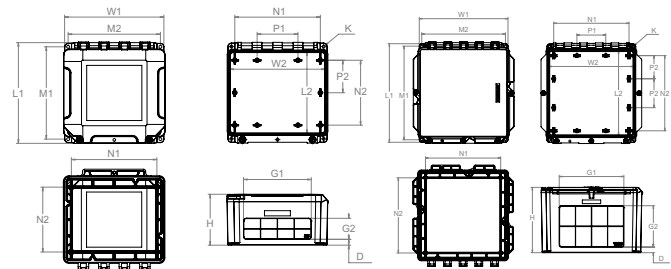

JBXH884 - JBXH887

JBXH12106 - JBXH161610

NEMA Rated: 1,2,3R,4,4X,12,13

Size inches	Part Number	Product Code	L1	W1	L2	W2	H	M1	M2	G1	G2	N1	N2	P1	P2	D	K
8x8x4	JBXH884	278400	9.58	9.58	7.86	9.2	4.9	8.9	8.9	6.47	1.97	8.25	6.26	3.94	3.13	0.59	0.28
8x8x7	JBXH887	278401	9.47	9.47	7.86	9.2	7.9	8.9	8.9	6.22	4.65	8.25	6.26	3.94	3.13	0.75	0.28
12x10x6	JBXH12106	278402	11.51	12.17	9.67	11.67	6.9	10.8	11.49	8.03	3.78	10.25	8.26	3.94	2.16	0.67	0.28
12x12x4	JBXH12124	278403	13.58	12.24	11.74	11.74	4.9	12.9	11.56	9.28	2.03	10.26	10.25	3.94	3.13	0.56	0.28
12x12x6	JBXH12126	278404	13.51	12.17	11.74	11.74	6.9	12.83	11.49	9.03	3.78	10.26	10.25	3.94	3.13	0.67	0.28
12x12x8	JBXH12128	278405	13.44	12.10	11.74	11.74	8.9	12.76	11.42	8.81	5.64	10.26	10.25	3.94	3.13	0.76	0.28
14x14x8	JBXH14148	278406	15.72	14.39	13.80	13.80	9.1	15.10	13.70	11.05	5.69	12.25	10.26	3.94	3.16	0.83	0.33
14x14x10	JBXH141410	278407	15.66	14.32	13.80	13.80	11.1	14.98	13.64	11.05	7.55	12.25	10.26	3.94	3.16	0.83	0.33
16x16x10	JBXH161610	278408	17.64	16.30	15.71	15.71	11.1	17.0	15.60	12.55	7.55	14.25	12.26	4.71	4.09	0.83	0.33

## Kraloy JBox Pole Mounting Kit

- Available in either galvanized or stainless steel (SS)
- Supplied as complete kits (sold separately)
- Works with wood, concrete, steel and composite poles
- Installs on round, square & octagonal poles up to 15"



Part Number	Product Code	Fits JBox
PMK4-12	077940	4" to 12"
PMK4-12SS	077946	4" to 12"
PMK14-16SS	277086	14" to 16"

## Kraloy JBox Back Panels

- Made of 14 gauge carbon steel
- White epoxy powder-coated finish
- Easy to cut and drill to mount devices

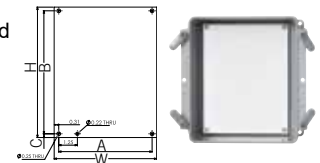

Size inches	Part Number	Product Code	W	H	A	B	C
6x6	BP66CSW	077864	4.88	6.75	4.26	6.25	0.25
8x8	BP88CSW	077861	6.88	8.75	6.26	8.25	0.25
12x10	BP1210CSW	077862	8.88	10.75	8.26	10.25	0.25
12x12	BP1212CSW	077865	10.88	10.75	10.26	10.25	0.25
14x14	BP1414CSW	077867	10.88	12.75	10.26	12.25	0.25
16x16	BP1616CSW	077868	12.88	14.75	12.26	14.25	0.25

## Performance Ratings

### MAXIMUM TEMPERATURE RANGE:

Maximum ambient temperatures to 122°F (50°C) as per the NEC

### RECOMMENDED OPERATING TEMPERATURE:

-40°F to 122°F (-40°C to 50°C)

### UV AND WATER EXPOSURE RATING:

UL 746C approved for exposure to UV and water

### FLAME & SMOKE RATING:

UL 94V-0 (UL94 Vertical Flame Test)

### NEMA ENCLOSURE RATINGS:

The Kraloy JBox is NEMA Rated 1, 2, 3R, 4, 4X, 6, 6P, 12, 13

### INDUSTRIAL CONTROL PANELS UL 508A:

Suitable to be used as an enclosure per section 18 of UL 508A

### CONDUCTORS:

Suitable for use with 90°C Rated Conductors

## The RIGHT BOX for the RIGHT Environment



Tested to perform in demanding industrial environments, the Kraloy Hinged Cover JBox junction box has added features to make this the easiest box to use – no matter the situation.

### FEATURE & BENEFITS

- Hinged Cover
- Fastener System
- Integrated Gasket
- Flat Cover Conditions
- Flat Cover
- Grid Lines
- Molded Panel Mounts



## SCEPTALIGHT: The Light That Lasts

Whether you're looking for economical outdoor lighting solutions, corrosion-resistant fixtures for punishing industrial environments or energy-saving LED,

Sceptalight fixtures are made from a glass-reinforced thermoplastic polyester resin, which offers outstanding corrosion and chemical resistance. And its interior and exterior silicone gaskets create a watertight seal, the reason it performs equally well indoors and outside. This thermoplastic design marries an unrivaled balance of strength, stiffness and toughness with all the benefits users appreciate of Scepter Rigid PVC Conduit and Kraloy Fittings – long life, easy servicing and high impact-resistance.

### Features and Benefits

Available in LED to suit a variety of applications

- Stable Construction
- Adaptable
- Watertight Seal
- Long Life
- Indoor/Outdoor Use
- Corrosion Resistant
- Durable, Impact Resistant



### Wet Locations

C22.2 No. 250  
CSA Listed to UL 1598  
Minimum 60°C supply conductors

CSA certified for wet locations, Sceptalight fixtures are built to withstand any environment where liquids drip, splash or flow against electrical equipment. And our polycarbonate globes are an excellent alternative to glass in punishing environments where high impact resistance is important. Sceptalight fixtures can operate in extreme temperatures and are resistant to damaging ultraviolet rays. For years, our fixtures have been proven performers on docks, wharfs, decks, walkways, shipyards and a variety of other applications where exposed to the elements.



### Hazardous Locations

CSA Listed to UL 844  
CLASS I, DIV 2 Groups A, B, C & D  
CLASS II, DIV 2 Groups F & G  
Minimum 90°C supply conductors

Sceptalight offers fixtures that are CSA certified for hazardous locations, making them the ideal choice for specific harsh industrial environments involving flammable or explosive gases, vapours or dusts. In addition to their sturdy construction, all our fixtures rated for hazardous locations include a heat-treated globe designed to endure drastic temperature changes such as direct spray of cool water on a hot fixture. Sceptalight fixtures are equipped with brass screws and inserts to ensure performance in punishing industrial conditions.

## Sceptalight LED



Introducing three Sceptalight LED products: the LED Retrofit Light Engine, the Heavy-Duty LED Light Fixture and the Utility LED Light Fixture. Sceptalight LEDs offer significant energy savings, up to 85% compared to incandescent, and up to 34% compared to fluorescents. Moreover, Sceptalight LEDs can last beyond 50,000 hours without a single need for maintenance.

Constructed of very strong and durable materials, the polycarbonate globe is impact resistant and is resistant to UV light degradation. The specially designed aluminum heat sink dissipates the heat generated by the LEDs to the exterior environment ensuring long-life and optimal performance in both hot and cold environments. Sceptalight LEDs have been tested and certified for use in indoor, outdoor, wet location, wash down, corrosive and hazardous\* environments. They are certified to the latest LED light fixture standards and NEMA 4X approved.

\* LVFP-LED-HAZ only

#### Retrofit Option

Sceptalight LEDs can easily retrofit onto existing installations for increased energy savings

#### Dimmable

Lights are dimmable down to 5% for maximum control of the lighting environment

#### Corrosion Resistant

Heat sink is coated with a durable e-coat layer that prevents corrosion

#### NEMA 4X and IP66 Rated

Approved for wet locations, wash down and corrosive environments

#### Heat Dissipation

Specially designed heat sink ensures long life and optimum performance for over 50,000 hours

#### Energy Efficient

1,575 lumens of light output is produced with only 15 Watts of electricity

#### Polycarbonate Globe

Impact and weather resistant for tough environments

## Sceptalight LED



**RETROFIT OPTION**  
Sceptalight LEDs can easily retrofit onto existing installations for increased energy savings.

**CORROSION RESISTANT**  
Heat sink is coated with a durable e-coat layer that prevents corrosion.

**NEMA 4X & IP66 RATED**  
Approved for wet locations, wash down and corrosive environments.

**HEAT DISSIPATION**  
Specially designed heat sink ensures long life and optimum performance for over 50,000 hours.

**ENERGY EFFICIENT**  
1,575 lumens of light output is produced with only 15 Watts of electricity.

**POLYCARBONATE GLOBE**  
Impact and weather resistant for tough environments.

**DIMMABLE**  
Lights are dimmable down to 5% for maximum control of the lighting environment.



## Wet Location Use

Ceiling Mount w/ Frosted Polycarbonate Globe	Part Number	Product Code	Hub Sizes
15W LED Retrofit Light Engine	LLED-15	277120	-
15W LVPF Heavy Duty Light Fixture	LVPF-LED-HAZ	277121	4 x 3/4"
15W LVPE Utility Light Fixture	LVPE-LED	277122	2 x 1/2" to 2 x 3/4"

Wall Mount Bracket (for WET Locations)	Part Number	Product Code
For wall mount fixtures select and order the appropriate style (wattage and globe) ceiling mount fixture from above and add LWB150 Wall Mount bracket	LWB150	077233



## Hazardous Locations

Ceiling Mount w/ Frosted Polycarbonate Globe	Part Number	Product Code	Hub Sizes
15W LVPF Heavy Duty Light Fixture	LVPF-LED-HAZ	277121	4 x 3/4"

All hazardous location fixtures are rated CLASS I, DIV 2 Groups A, B, C & D and CLASS II DIV 2 Groups F & G.

## Mounting Options

Sceptalight LED can be retrofit with Ceiling Mounts only.

Ceiling Mount Box with threaded hubs and integral mounting feet

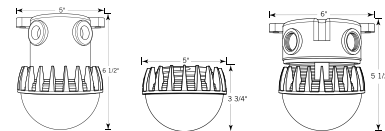

## EPR Kits for Conduit Repair

EPR Kits are the first total repair systems for broken and damaged PVC conduit. They offer fast and easy repairs for damaged conduit caused by actions such as earth excavation, horizontal and core drilling.

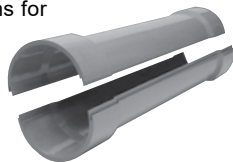

With unique interlocking joints, the EPR Kits' two half shell bell by bell pieces simply close around the installed wire and cable. Using standard PVC solvent cement, EPR Kits are quickly and easily assembled and connected, restoring the conduit to its original form.

EPR Kits are manufactured of high-impact and non-conductive PVC, ensuring a life long quality repair for your system.

Size (in)	Part Number	Product Code	Length (in)
1-1/4	EPR25	077982	24
1-1/2	EPR30	077981	24
2	EPR35	077980	24
2-1/2	EPR40	077960	24
3	EPR45	077958	24
4	EPR55	077957	24
5	EPR60	077956	24
6	EPR65	077955	24

## Repair Kit for Conduit



- ◆ Available in sizes 1-1/4" to 6"
- ◆ Restores structural integrity of conduit and duct system
- ◆ Cost savings with fast and easy installation
- ◆ Special interlocking joints provide water-tight seal
- ◆ Ideal for the repair of electrical, telecommunication, utility and CATV applications



## Kwikon® ENT Savings for the Long Run

Noncorroding and nonconducting, Kwikon Electrical Nonmetallic Tubing and fittings are designed *For The Long Run*. Coiled in lengths up to 1,500 feet, the Kwikon system can span the longest run. Encased in concrete, concealed in walls or ceilings, Kwikon offers the best alternative to the labor-intensive, 10' lengths of metal conduit with its couplings and scrap.

Now you can use the Kwikon ENT system for communications (yellow), fire alarm and emergency (red), as well as power (blue) applications. It comes with color-coded stripes for easy identification on 1,500 ft., 1000 ft. and 750 ft. reels. The Kwikon ENT system is the right choice.

## Kwikon Fittings

Our unique Kwikon couplings, transition couplings and connectors are designed with six 360° locking tabs to ensure a secure concrete-tight connection. Should water-tight connections or transitions to Rigid PVC Conduit be required, Kwikon ENT may be joined to Rigid PVC Fittings using solvent cement. This practice of solvent welding ENT is acceptable as per NEMA TC-13 Section 3.1.2 "Joints." Normal application of solvent cement may be used inside the Rigid PVC socket while it is recommended to apply cement sparingly on the Kwikon ENT pipe end before assembly.

Time-consuming taping and solvent welding are eliminated. Kwikon fittings are permitted for use with all UL Listed and CSA certified ENT.

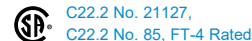

### Ease of Installation

Engineered for the rugged day-to-day challenges of the construction industry, Kwikon has already established itself as a market leader. Requiring no special tools for bending or cutting, Kwikon is easily installed.

### Bending & Cutting

Kwikon's corrugated construction allows it to be easily bent by hand, no longer requiring special bending equipment traditionally required with metal conduit systems. When bending, ensure the radius of the curve is at least six times the internal diameter of the tubing.

### Kwikon Slab Boxes

Kwikon slab boxes are available with or without molded connectors. For boxes without molded connectors, preassembly is quick and simple using our snap-in male adapter. This provides a secure concrete-tight connection.

### Pre-Assembly of Metallic Boxes

Metal slab boxes can be quickly preassembled with Kwikon threaded male adapters with locknuts. All Kwikon connectors provide a concrete-tight connection.

### Installation in Sheer Walls, Interior Walls & Block Walls

Kwikon's flexibility, lightweight and ease of handling in metal, wood or block walls, combined with Kwikon connectors and couplings, substantially reduce time and labor needed to install electrical raceways.

### Use in Ceilings

Kwikon ENT is permitted for use in ceilings where not subject to physical damage and in buildings 3 storeys or more provided the ceiling provides a 15-minute finish rating.

### Exposed Work

ENT is permitted to be used for exposed work, where not subject to physical damage, in buildings not exceeding 3 floors above grade.



### Pulling Wire

Kwikon's interior corrugated surface greatly reduces the amount of friction while pulling conductors through long runs, even with 90° bends.

### Transition from ENT to EMT

Transition from ENT to EMT no longer requires solvent welding. Simply connect the Kwikon transition coupling to EMT with the set screw and snap on to ENT.

### NEC, Article 362

Rules governing the installation of Kwikon ENT are covered in the 2008 National Electrical Code, ANSI/NFPA Article 362. Kwikon ENT systems are recognized for use in places of assembly as referenced in Articles 518 & 520.

Kwikon ENT may be installed exposed, in areas not subject to physical damage where the building does not exceed three floors above grade [(362.10 (1))].

Kwikon ENT may be concealed in floors, walls, ceilings and suspended ceilings where a thermal barrier of material has a minimum of 15-minute finish rating.

**NOTE:** *Kwikon ENT may penetrate fire-rated walls, floors or ceilings with a UL Listed or recognized through-penetration fire-stop system.*

### Fire Resistive Construction & Wall Assemblies

Kwikon ENT tubing, Kwikon fittings and Kwikon slab boxes are approved for use in noncombustible 2 hr. and 4 hr. fire rated floor-ceiling assemblies. Normal weight concrete cover must be provided of a minimum of 2-1/8" for 2 hr. assemblies and 2-3/8" for 4 hr. assemblies. [ULI File: E 78276 and ULC File: R-19226].

Kwikon ENT and Kwikon fittings have been investigated for use in a nonload-bearing wall and partition assembly. The report (ULC CR2196) concludes the wall assemblies with Kwikon ENT and fittings will provide a 2 hr. resistance to the passage of flame and dangerous transmission of heat.

### Storage and Handling

- NOT to be installed, stored, or handled in cold temperatures below -20°C (-4°F).
- NOT to be stored outside

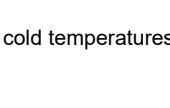
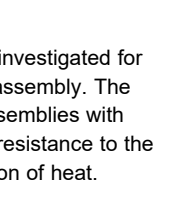
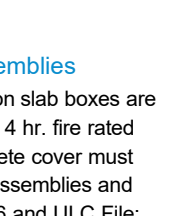
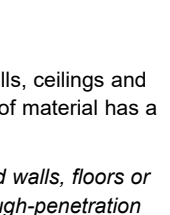

## Dimensions

Nominal Size		Average O.D.		Average I. D.	
inches	mm	inches	mm	inches	mm
1/2	12	0.84	21.3	0.602	15.3
3/4	20	1.05	26.7	0.804	20.4
1	25	1.315	33.4	1.029	26.1
1-1/4	32	1.66	42.2	1.360	34.5
1-1/2	40	1.90	48.3	1.590	40.4
2	50	2.375	60.3	2.047	52.0
2-1/2	65	2.866	72.8	2.469	62.7

## Kwikon ENT - Blue Stripe

	Size (in)	Length (ft)	Product Code	Weight lbs/pkg
Reel	1/2	1500	012002	165
	3/4	1000	012011	158
	1	750	012021	160
	1-1/4	1000	012047	193
	1-1/2	750	012033	205
	2	500	012044	220
	2-1/2	325	012049	70
Coil	1/2	200	012031	20
	3/4	100	012040	12.5
	1	100	012041	17
	1-1/4	500	012046	76
	1-1/2	300	012032	50.5
	2	225	012043	69.5

Wrapped in plastic, coils are easily dispensed from the center.

## Kwikon ENT Reels - Color Coded

Size (in)	Length (ft)	Product Code			Weight lbs/reel
		Red	Yellow	Blue	
1/2	1500	012305	012335	012002	165
3/4	1000	012307	012337	012011	158
1	750	012310	012340	012021	160
1-1/4	1000	012037	012038	012047	193
1-1/2	750	012035	012036	012033	205
2	500	012039	012042	012044	220

## Storage of Kwikon ENT Tubing

Manufacturer recommends that ENT tubing should not be stored outdoors where subjected to direct sunlight without protective covering, i.e. packaging or tarps.

## Kwikon ENT - 10' Sticks with Blue Stripe

Size (in)	Length (ft)	Product Code	Crate Qty
1/2	10	012001	3,600
3/4	10	012010	2,200
1	10	012034	1,800

## Kwikon Coupling

Size (in)	Part Number	Product Code
1/2	KC10	089000
3/4	KC15	089001
1	KC20	089002
1-1/4	KC25	189670
1-1/2	KC30	189671
2	KC35	189672
2-1/2	KC40	089075



## Kwikon Connector

Size (in)	Part Number	Product Code
1/2	KTA10	089006
3/4	KTA15	089007
1	KTA20	089008
1-1/4	KTA25	189680
1-1/2	KTA30	189681
2	KTA35	189682
2-1/2	KTA40	089076



## Kwikon Snap-in Connector

Size (in)	Part Number	Product Code
1/2	KTS10	089146
3/4	KTS15	089147
1	KTS20	089148



## Kwikon Transition Coupling

Size (in)	Part Number	Product Code
1/2	KTC10	089012
3/4	KTC15	089013
1	KTC20	089014



All Kwikon ENT is UL Listed for use in walls, floor slabs and ceilings, as outlined in Article 362 of the 2008 NEC Code.

## Kwikon 90° Stub Down Fittings

### KT90 Stub Down Fittings (Kwikon x Threaded)

Size (in)	Part Number	Product Code
1/2	KT90-10	089060
3/4	KT90-15	089059
1	KT90-20	089058



### KK90 Stub Down Fittings (Kwikon x Kwikon)

Size (in)	Part Number	Product Code
1/2	KK90-10	089055
3/4	KK90-15	089056
1	KK90-20	089057



## ENT Support Unit (ESU)

The ESU is designed to raise the tubing or conduit off the concrete form during the concrete pour maintaining a level raceway.

- One size fits all 1/2" – 2"
- Saves time and labor
- Easy locking mechanism
- Securable to the concrete form
- Minimal footprint reduces amount of surface contact



Part Number	Product Code
ESU-10-35	089149

## Kwikon ENT Form Stubby

Size (in)	Part Number	Product Code
1/2	KSTB-10	089330
3/4	KSTB-15	089331
1	KSTB-20	089332
1-1/4	KSTB-25	089333



## Kwikon ENT Angled Form Stubby

Size (in)	Part Number	Product Code
1/2	KASTB-10	089233
3/4	KASTB-15	089234
1	KASTB-20	089235
1-1/4	KASTB-25	089236
1-1/2	KASTB-30	089238
2	KASTB-35	089239
2-1/2	KASTB-40	089240



## Kwikon ENT Multi-Link™ Form Stubby

Size (in)	Part Number	Product Code
1/2	MSTB-10	089031
3/4	MSTB-15	089026
1	MSTB-20	089025



## Tapered Plugs

Size (in)	Part Number	Product Code
1/2	TP10	089003
3/4	TP15	089004
1	TP20	089005



## Kwikon Cutter & Blades

Description	Part Number	Product Code
Cutter (1/2"- 1")	CLC20	089066
Blades for CLC20	SSB	089067
Cutter (1/2"- 2")	CLC35	089068
Blades for CLC35	SB35	089069





### Kwikon Slab Boxes

Engineered to be rugged and durable, Kwikon slab boxes withstand construction's harshest environments. Designed by contractors for contractors, Kwikon slab boxes are available in two unique styles, with or without molded connectors. Now you can provide a complete, nonmetallic slab system. Priced competitively with traditional steel mud boxes, Kwikon slab boxes increase labor efficiencies, reducing costs.

#### Standard Slab Boxes

Slab Box w/ Molded Connectors - Vol 44 cu in.

Hub Size (in)	Part Number	Product Code
8x1/2	SMB-H-10	089465
8x3/4	SMB-H-15	089462
4x1/2, 4x3/4	SMB-H-10/15	089458
4x1/2, 2x1/4, 2x1	SMB-H-10/15/20	089466
4x3/4, 4x1	SMB-H-15/20	089464



Slab Box w/o Molded Connectors - Vol 44 cu in.

Knockout Size (in)	Part Number	Product Code
8x1/2	SMB-10	089460
4x1/2, 2x3/4, 2x1	SMB-10/15/20	089461



#### 4" Square Slab Box

Slab Box w/ Molded Connectors - Vol 44 cu in.

Hub Size (in)	Part Number	Product Code
8x1/2	SSBH-10	089467
8x3/4	SSBH-15	089468
4x1/2, 2x3/4	SSBH-10/15	089469
4x1/2, 2x3/4, 2x1	SSBH-10/15/20	089474
4x3/4, 4x1	SSBH-15/20	089475



#### Slab Box Extension Ring

Part Number	Product Code
SMBR	089494



Adjusts height of SMB/SMBH series slab boxes by 1"

### Shallow Slab Box

Shallow Slab Box with Molded Connectors - Vol 36 cu in.

Hub Size (in)	Part Number	Product Code
8x1/2	SMBS-H-10	089480
4x1/2 & 4x3/4	SMBS-H-10/15	089481
8 x 3/4	SMBS-H-15	089482
4x1/2, 2x3/4, 2x1	SMBS-H-10/15/20	089483
4x3/4 & 4x1	SMBS-H-15/20	089484



Shallow Slab Box w/o Molded Connectors - Vol 36 cu in.

Hub Size (in)	Part Number	Product Code
8x1/2	SMBS-10	089490
4x1/2, 2x3/4, 2x1	SMBS-10/15/20	089491

### ENT Mud Box

Slab Box with Molded Connectors (Hubs) - Vol 29 cu in.

Connectors (in)	Part Number	Product Code
8x1/2	MBH-10	089022
8x3/4	MBH-15	089018
4x1/2, 2x3/4, 2x1	MBH-10/15/20	089019
4x1/2, 4x3/4	MBH-10/15	089020
4x3/4, 4x1 knockouts	MBH-15/20	089021



Slab Box with Knockouts - Vol 29 cu in.

Connectors (in)	Part Number	Product Code
4x1/2, 2x3/4, 2x1	MB-10/15/20	089016
8x1/2" knockouts	MB-10	089017

## Concrete Wall Box

A Kwikon Concrete Wall Box arrives fully assembled with the hubs, protective poly film and single gang opening all installation ready.

- Fully assembled and installation ready
- Perfectly suited for deep or shallow construction preferences
- Kwikon hubs do not protrude inside the box
- Clear Cover vacuum formed removable covers

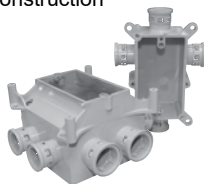

3-1/2" Deep Box - Vol 38 cu in.

Size (in)	Part Number	Product Code
4x1/2, 4x3/4	SVDB-H-10/15	089496
4x3/4, 4x1	SVDB-H-15/20	089049
4x1/2, 2x3/4, 2x1	SVDB-H-10/15/20	089052
8x3/4	SVDB-H-15	089065

2" Shallow Box - Vol 15 cu in.

Size (in)	Part Number	Product Code
4x1/2	SVSB-H-10	089054
4x3/4	SVSB-H-15	089053



## The Industry Leader in PVC Conduit Fittings

**EPR**



- Fast and easy installation
- Restores structural integrity
- Repair made while leaving cables inside



**Sceptalight**



- Wet or hazardous locations
- Water-tight seal protects from moisture & corrosion
- Impact resistant – ideal for indoor & outdoor use



**KRALOY**



- High tensile & impact strength
- Concrete-tight
- FT-4 rated



**FITTINGS:**

ENT fittings shall be manufactured of high impact PVC

ENT fittings requirements:

Provide fittings meeting the following requirements:

- Six locking tabs located every 60° providing 360° contact
- Locking tabs shall provide a pullout of a minimum 175 ft-lb force
- Concrete tight without the need for taping
- When transitioning to EMT conduit, the transition fitting shall have six locking tabs for ENT connection and set-screw connection for EMT

**BOXES:**

ENT boxes shall be manufactured of high impact PVC

ENT slab box and wall box requirements:

- Slab boxes shall be approved for the purpose and concrete-tight
- Slab boxes shall have eight (8) integrally molded ENT hub connectors with six locking tabs for ENT raceway connection

**INSTALLATION**

ENT raceways, fittings, boxes and accessories shall be installed in accordance with Article 362 of the 2008 National Electrical code.

Where ENT penetrates a fire rated wall, floor or ceiling assembly, an approved firestop system as listed in Underwriters Laboratories Building Materials Directory or other nationally recognized testing laboratory shall be used.

Not permitted for use where subject to ambient temperatures in excess of 122°F (50°C)

**Short Form Sample Specification****General****REFERENCES:**

Standards referred to in this section are:

- UL 1653 Electrical Nonmetallic Tubing
- NEMA TC-13 Electrical Nonmetallic Tubing

**Products****MANUFACTURERS:**

Acceptable manufacturers are listed below:

- Electrical Nonmetallic Tubing - Kwikon by IPEX Electrical Inc.
- Electrical Nonmetallic Tubing Fittings - Kwikon by IPEX Electrical Inc.
- Electrical Nonmetallic Tubing Boxes - Kwikon by IPEX Electrical Inc.

All ENT tubing, ENT fittings, ENT boxes and accessories shall be manufactured by the same company so as to form a complete ENT system.

ENT systems shall be approved for use in fire resistance rated concrete floor-ceiling assemblies with fire resistance ratings up to 4 hours.

**RACEWAYS:**

ENT raceway shall be color coded to indicate the wiring system. Blue stripe for power, red stripe for fire alarm/emergency systems and yellow stripe for data/communications.

ENT raceway shall be listed to UL1653 and manufactured in accordance with NEMA TC-13.

Full flange prevents box from twisting and sinking into foam if over-tightened

INEXO provides a 1/2" drywall setback resulting in a professional finish

Insertion depth of 2-1/4"

'TEETH' can be easily removed and replaced

'TEETH' lock in place providing a rigid hold in the EPS foam

Greater installation versatility with 3 screw hole choices and flanges on both sides

Single gang box provides 19 cubic inch capacity

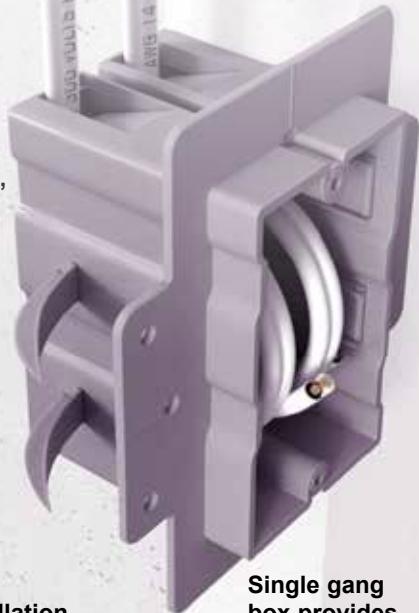

## THE INNOVATIVE ELECTRICAL BOX FOR INSULATED CONCRETE FORM CONSTRUCTION

INEXO® Electrical Boxes - the only approved electrical box for ICF construction!

Available in commercial and residential styles.



### INEXO Boxes for ICF Construction

Until now there have been few choices when attempting to provide a truly professional electrical box solution for Insulated Concrete Form homes.

INEXO's patented design provides a solution that works with your production schedule and provides the quality installation and finished look that builders require and owners appreciate. INEXO boxes link seamlessly with existing ICF materials, tools and methods. A complete offering designed for ICF walls allow builders to standardize on the use of electrical boxes throughout the building.

#### Residential (NMD Cable 14/2 – 10/3)

Description	Part Number	Product Code
Single Gang	ICF-1-RL	220000
Double Gang	ICF-2-RL	220001
Triple Gang	ICF-3-RL	220002

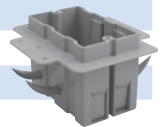

#### Commercial (AC or NMD Cable 14/2 – 10/3)

Description	Part Number	Product Code
Single Gang	ICF-1-CLU	220009
Double Gang	ICF-2-CLU	220010
Triple Gang	ICF-3-CLU	220011



#### Low Voltage Divider

Description	Part Number	Product Code
Divider	LVD-RL	220100
For residential box only		



NOTES

---

---

---

---

---

---

---

---

---

---

---

---

---

---

---

---

---

---

---

---

---

---

---

---



**KWIKFLEX NMLT Type B on reels are UL Listed in all lengths**

Available in sizes from 3/8" to 2", reels offer the end user the best possible continuous length in the market place. Its patented design offers a low profile coupling that when two conduits are connected it is hardly noticeable and allows the user to run the conduit at any length desirable. There is no longer any need for additional parts when making a long conduit run.

**Kwikflex - NMLT Flexible Conduit (Grey) Type B**



Size (in)	Product Code	Length (ft)
3/8	165005	100
1/2	165007	100
3/4	165009	100
1	165011	100
1-1/4	165014	100
1-1/2	165017	50
1-1/2	165021	100
2	165020	50



### NMLT Flexible Conduit Reels (Grey) Type B

Size (in)	Product Code	Length (ft)
1/2	165082	1000
3/4	165085	700
1	165090	500



### NMLT Extra Flexible Tubing (Black)

Kwikflex Extra Flexible Nonmetallic Liquidtight conduit is listed. Suitable for indoor and outdoor use and resistant to oil, water and most chemicals, Kwikflex Extra Flexible offers an increased bending radius over regular NMLT. The service temperature range of Kwikflex Extra Flexible is a broad -5°F to 140°F.

Size (in)	Product Code	Length (ft)
3/8	165055	100
1/2	165057	100
3/4	165059	100
1	165061	100
1-1/4	165064	100
1-1/2	165067	50
2	165070	50



### NMLT 90° Elbows (Grey)

Size (in)	Part Number	Product code
3/8	LTB03/90	065306
1/2	LTB10/90	065307
3/4	LTB15/90	065310
1	LTB20/90	065312
1-1/4	LTB25/90	065314
1-1/2	LTB30/90	065317
2	LTB35/90	065320



### NMLT Straight Fittings (Grey)

Size (in)	Part Number	Product code
3/8	LTS03	065326
1/2	LTS10	065327
3/4	LTS15	065330
1	LTS20	065332
1-1/4	LTS25	065334
1-1/2	LTS30	065337
2	LTS35	065340



### NMLT Screw-on 90° Elbows (Grey)

Size (in)	Part Number	Product code
1/2	LTD10/90	065350
3/4	LTD15/90	065352



### NMLT Screw-on Straight Fittings (Grey)

Size (in)	Part Number	Product code
1/2	LTD10	065360
3/4	LTD15	065362



### NMLT Screw-on Multi Angle Fittings (Grey)

Size (in)	Part Number	Product code
1/2	LTMA10	065015
3/4	LTMA15	065016



## NOTES

---

---

---

---

---

---

---

---

---

---

---

---

---

---

---

---

---

---

---

---

---

---

---

---



### Vertical-Lok Spacers

Kraloy conduit interlocking spacers are available in a variety of spacing dimensions for all conduit sizes. Our most popular sizes are offered with unique rebar holder slots for quick reinforcing bar installation and the bases have support holes for securing the base spacers to the trench bottom.

Kraloy conduit spacers manufactured with the rebar holder slots can accommodate a maximum rebar diameter of  $5/8"$  for the 2" conduit size and  $7/8"$  for all other conduit size spacers. All conduit spacers provide a 3" clearance from the trench base to the bottom of the first conduit.

Kraloy recommends the installation of a spacer every 5 to 6 feet along the raceway length to provide the proper and even support of the conduit assembly.



Base

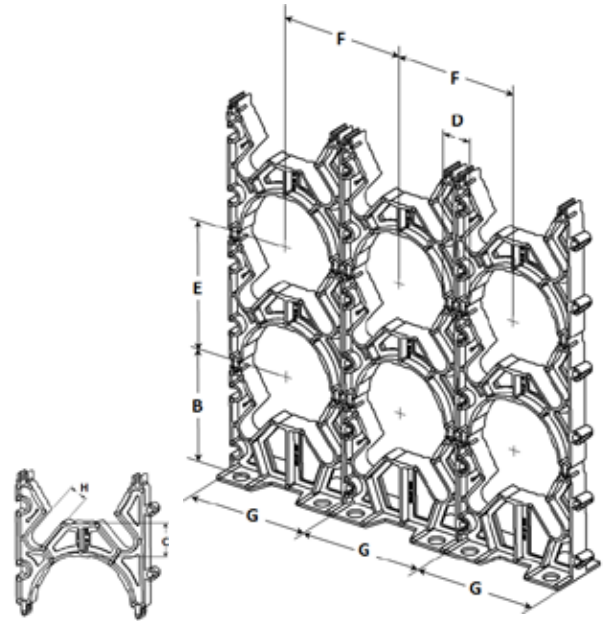

Intermediate

Size (inches)	Base VERTICAL-LOK SPACERS						Intermediate VERTICAL-LOK SPACERS							
	Part Number	Product Code	A	B	H	G	Part Number	Product Code	C	D	E	F	G	H
2 x 1-1/2	BS3530	029566	3.04	4.25	0.63	3.94	IS3530	029550	1.52	1.50	3.95	3.95	3.94	0.63
2 x 2	BS3535	029567	3.04	4.25	0.63	4.47	IS3535	029551	2.03	2.06	4.48	4.48	4.47	0.63
2 x 3	BS3545	029568	3.04	4.25	0.63	5.44	IS3545	029552	3.00	3.03	5.45	5.45	5.44	0.63
3 x 1-1/2	BS4530	029585	3.00	5.84	0.88	5.12	IS4530	029582	1.50	1.45	5.15	5.12	5.12	0.88
3 x 2	BS4535	029570	2.97	4.78	0.88	5.63	IS4535	029554	2.00	1.88	5.64	5.63	5.63	0.88
3 x 3	BS4545	029571	3.00	4.81	0.88	6.63	IS4545	029555	3.00	2.88	6.66	6.63	6.63	0.88
4 x 1	BS5520	029586	3.00	5.32	0.88	5.63	IS5520	029583	1.00	1.03	5.66	5.63	5.63	0.88
4 x 1-1/2	BS5530	029573	3.00	5.31	0.88	6.13	IS5530	029557	1.50	1.39	6.13	6.14	6.13	0.88
4 x 2	BS5535	029574	3.06	5.38	0.88	6.63	IS5535	029558	2.00	1.88	6.64	6.63	6.63	0.88
4 x 3	BS5545	029575	3.06	5.38	0.88	7.63	IS5545	029559	3.00	2.90	7.64	7.64	7.63	0.88
5 x 1-1/2	BS6030	029587	3.00	5.84	0.88	7.37	IS6030	029584	1.68	1.69	7.37	7.37	7.37	0.88
5 x 2	BS6035	029577	3.13	5.94	0.88	7.88	IS6035	029561	2.25	2.15	7.89	7.89	7.88	0.88
5 x 3	BS6045	029578	3.19	6.00	0.88	8.69	IS6045	029562	3.06	2.96	8.70	8.70	8.69	0.88
6 x 1-1/2	BS6530	029579	3.02	6.38	0.88	8.21	IS6530	029563	1.50	1.38	8.24	8.22	8.21	0.88
6 x 2	BS6535	029580	3.02	6.38	0.88	8.72	IS6535	029564	2.00	1.89	8.74	8.73	8.72	0.88
6 x 3	BS6545	029581	3.00	6.38	0.88	9.75	IS6545	029565	3.00	2.90	9.77	9.77	9.75	0.88
* 8 x 2	BS8035	029293	3.00	7.25	*	10.80	* IS8035	029294	2.06	2.00	10.58	10.80	10.80	*

\* Do not have rebar slots

\* Do not have rebar slots



**Challenge:**

4 lane highway  
6,000 cars/hour  
4,000 trucks/hour  
Silt and clay

**Solution:**

SceptaCon™  
Trenchless

## The SceptaCon™ Solution

### PVC raceway engineered for trenchless applications

SceptaCon is a water-tight PVC raceway system designed specifically for horizontal directional drilling (HDD) applications. No open-trenching, traffic interruptions or costly damage to roads and sidewalks.

With its slide-in spline locking system, SceptaCon comes together quickly – no special fusion equipment or training is needed. Assembled one pipe length at a time and then pulled underground, it eliminates the need for long strings of pipe on the jobsite. Able to link seamlessly with existing PVC conduit infrastructure, SceptaCon allows utilities to standardize on PVC throughout their entire electrical system.

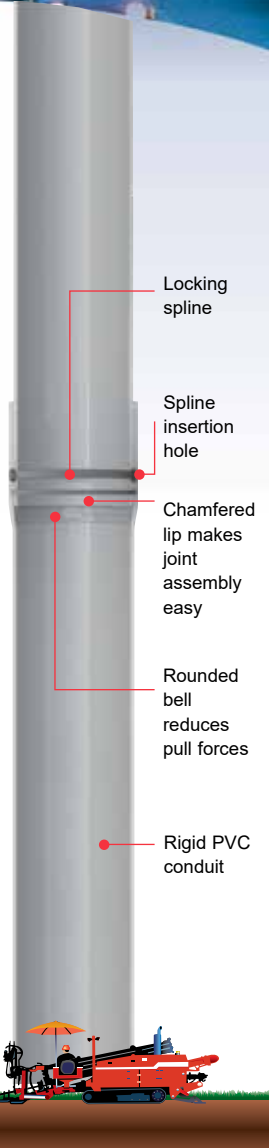

### SceptaCon™ Trenchless Raceway Systems

SceptaCon is one of the first PVC systems designed for the rigors of trenchless applications. It links seamlessly to existing PVC conduit infrastructures and allows utility companies to standardize on PVC throughout their entire electrical systems.

SceptaCon's slide-in locking system and pre-installed, pre-lubricated gaskets allow contractors to create a water-tight seal by hand in seconds - in all temperatures - without having to worry about solvents or chemicals freezing or drying too quickly.

Its unique spline-lock snaps into a recessed opening, ensuring the spline won't get snagged during pull-through. SceptaCon's rounded bell shoulders slide easily past roots, rocks and other debris in the borehole, ensuring a smooth, easy installation. And because SceptaCon is made to the same high standards as our Kraloy rigid PVC conduit, contractors and electrical utilities can be assured of the same level of quality - above ground and below.







For more information on Kraloy Fittings



Fax this form to (905) 844-1504

or



E-mail to [marketing@kraloyfittings.com](mailto:marketing@kraloyfittings.com)

PLEASE PRINT

Company

Name

Title

Address

City

State

Zip

Phone

ext.

Fax

E-mail / Website

**This is a:**

- Home Address     Business Address     Jobsite Address

**Business Type:** (check 1 or 2 that best apply)

**Company Classification:**

- Distributor/Wholesaler  
 Engineering Firm  
 Contractor  
 Government  
 OEM - Products Manufactured: \_\_\_\_\_  
 Other: \_\_\_\_\_

SIC or industry \_\_\_\_\_

**My primary markets are (check all that apply):**

- Commercial  
 Residential  
 Industrial  
 Other: \_\_\_\_\_  
 Utility  
 OEM  
 Institutional



# CUSTOMER SERVICE CENTER

1055 Wilton Grove Road  
London, Ontario N6N 1C9

Tel: (519) 681-2140  
Toll Free: (800) 265-1815  
Fax: (519) 681-2156

[www.kraloyfittings.com](http://www.kraloyfittings.com)

Kraloy has been an industry leader for over 40 years supplying the electrical trade with a comprehensive offering of nonmetallic PVC fittings. Kraloy offers adapters, couplings, elbows, access fittings, boxes, cover plates, expansion fittings and spacers – virtually any fitting required to complete the PVC conduit system.

Check out the full Kraloy product offering on our web site [www.kraloyfittings.com](http://www.kraloyfittings.com) or contact us directly for information.

Only when you specify Kraloy by name are you guaranteed The Fitting Choice.

Products are manufactured by IPEX Electrical Inc. and distributed in the United States by Kraloy, a division of Multi Fittings Corp.

Kraloy® is a trademark of Multi Fittings Corp.

INEXO™, JBox™, Kwikon®, Kwikflex®, SceptaCon™ and Sceptalight™ are trademarks of IPEX Branding Inc.

## DISTRIBUTED BY:

[www.kraloyfittings.com](http://www.kraloyfittings.com)

This literature is published in good faith and is believed to be reliable. However, Kraloy does not represent and/or warrant in any manner the information and suggestions contained in this brochure. Data presented is the result of laboratory tests and field experience. Kraloy maintains a policy of ongoing product improvement. This may result in modifications of features and/or specifications without notice.